

PROYECTO: LOS CASTILLOS

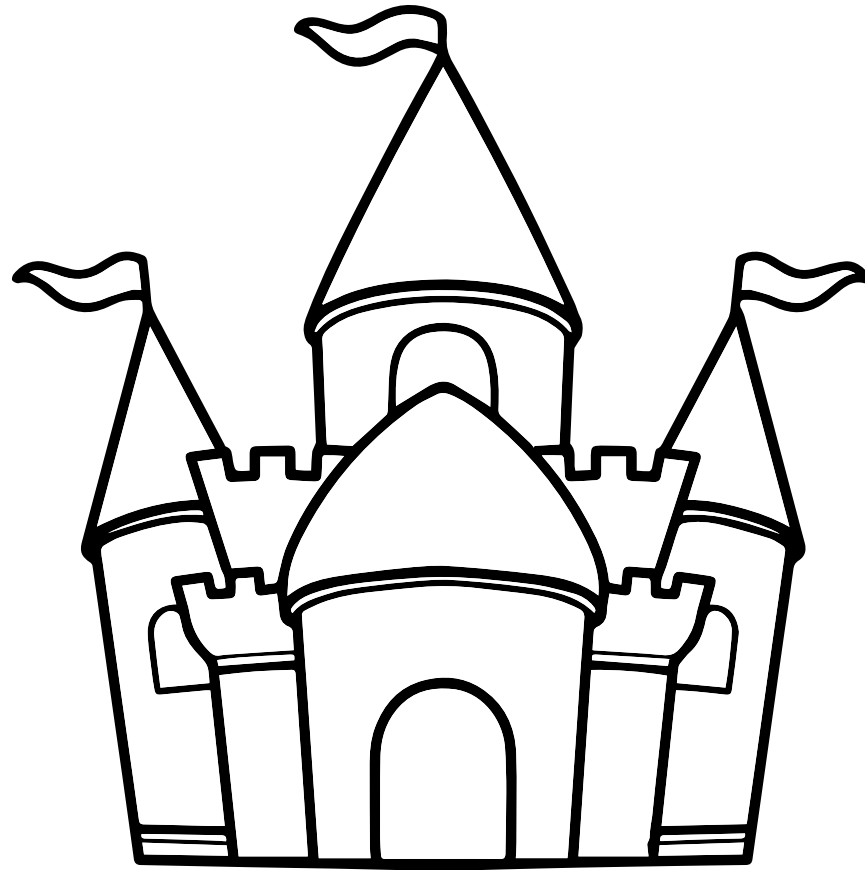

¿Qué sabes de los castillos?

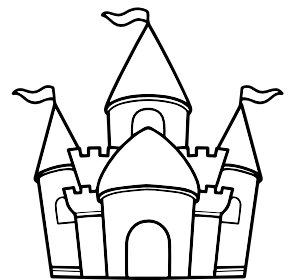

¿Qué sabes de los castillos?

Haz un dibujo

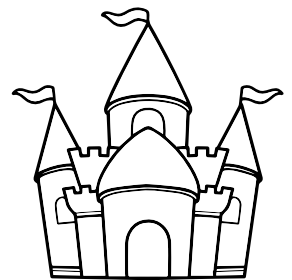

¿Qué te gustaría saber?

Haz un dibujo

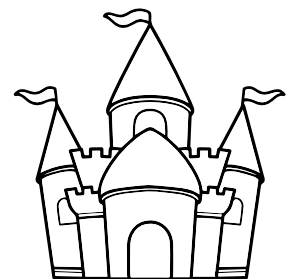

¿Qué sabes de los castillos?

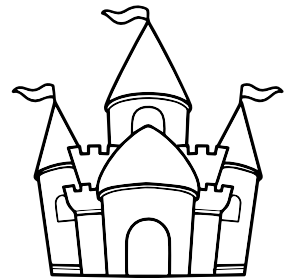

¿Qué te gustaría saber de los castillos?

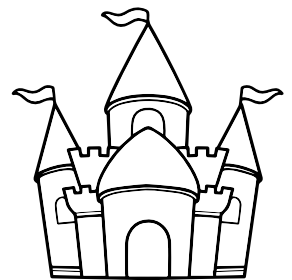

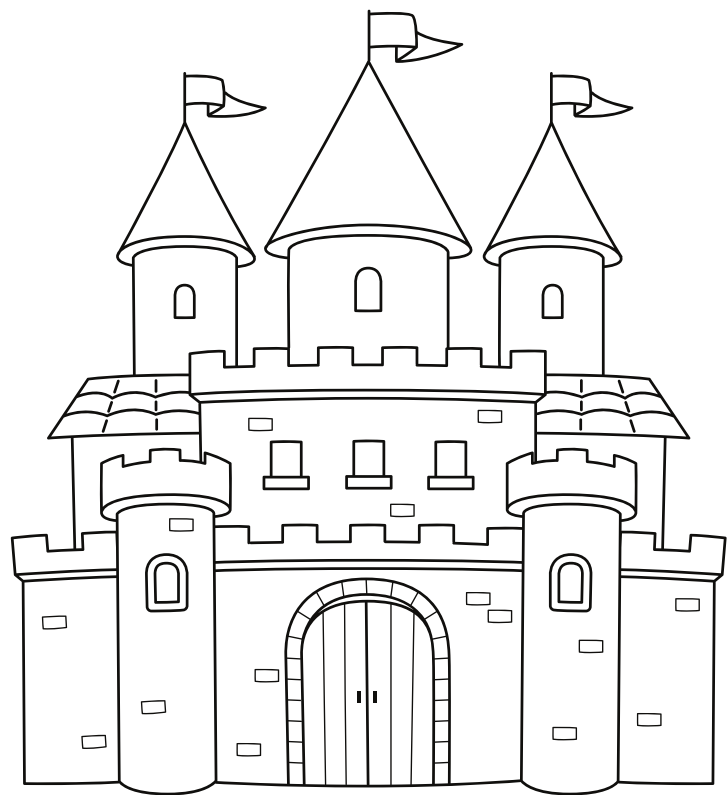

Castillo



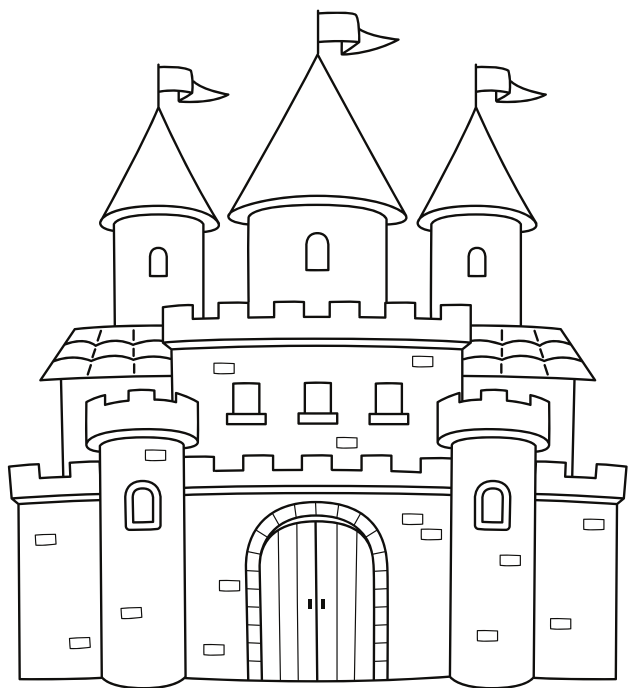

CASTILLO

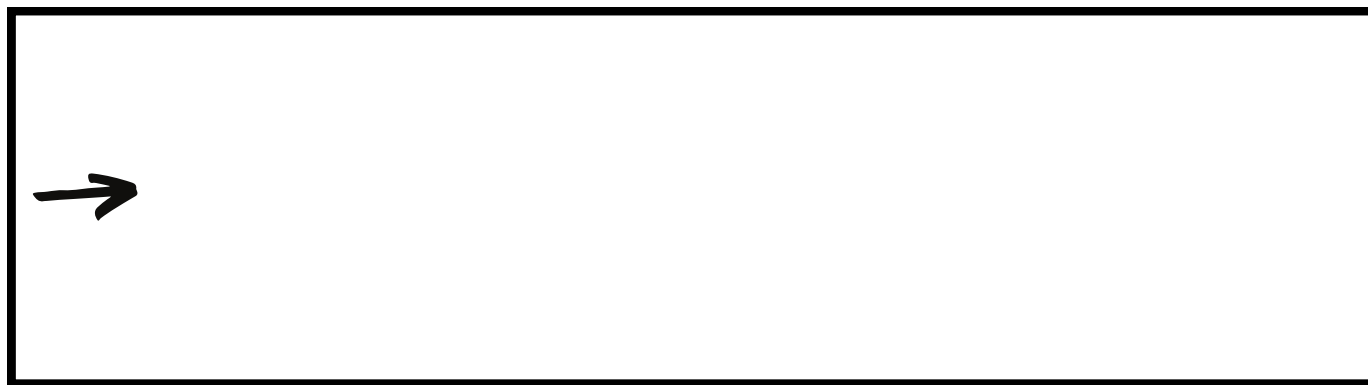

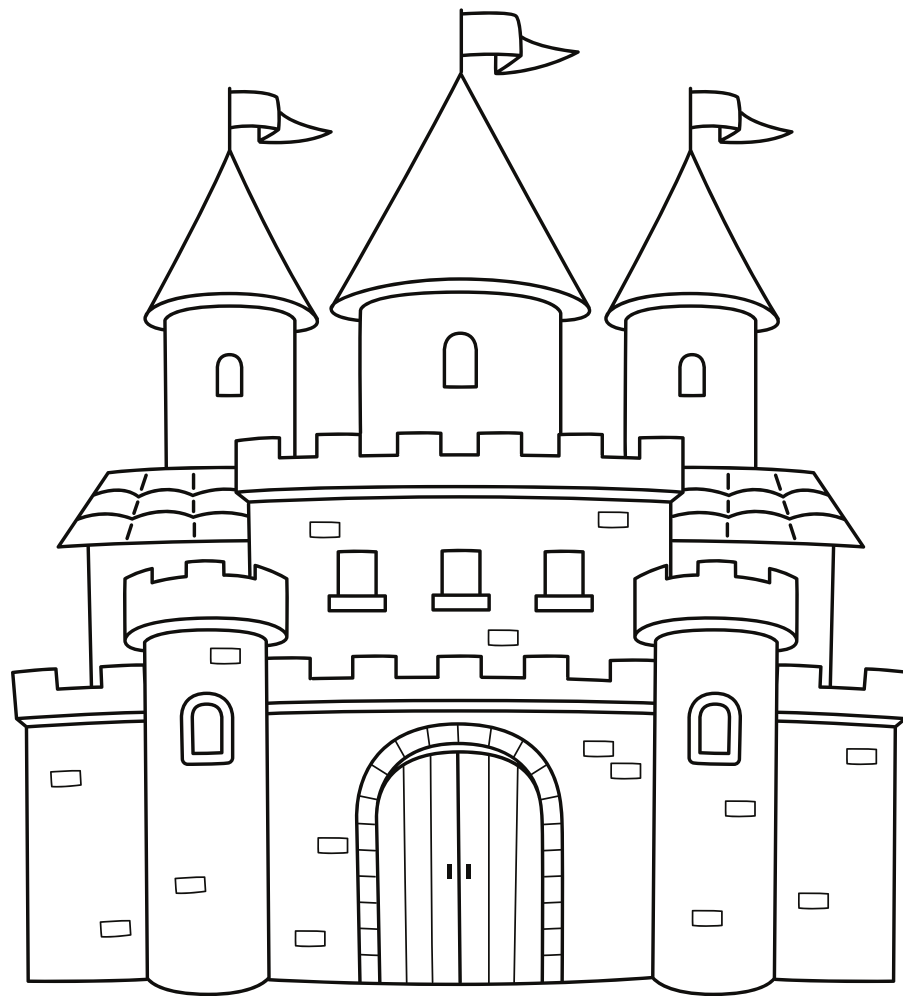

CASTILLO

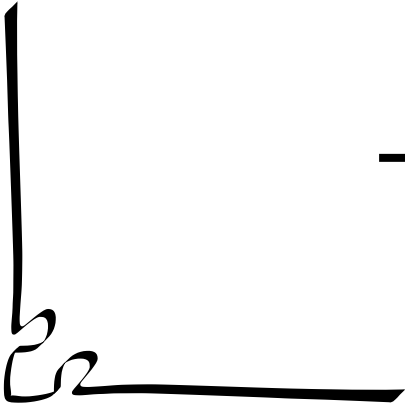
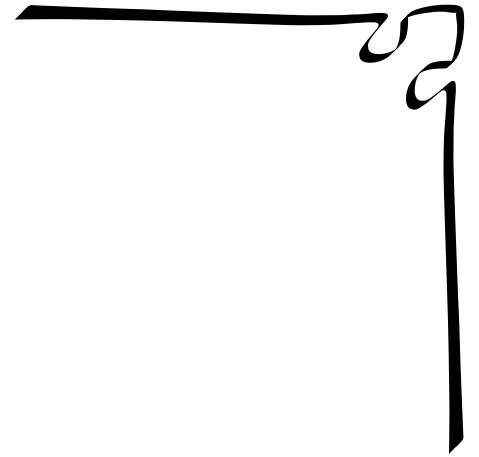
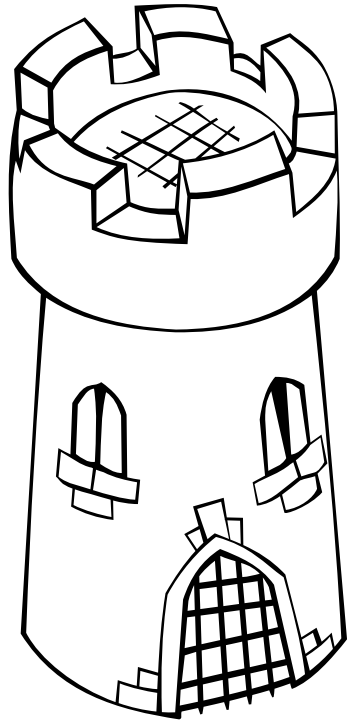

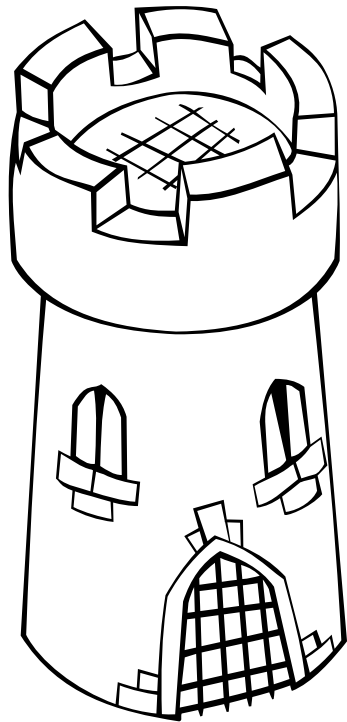

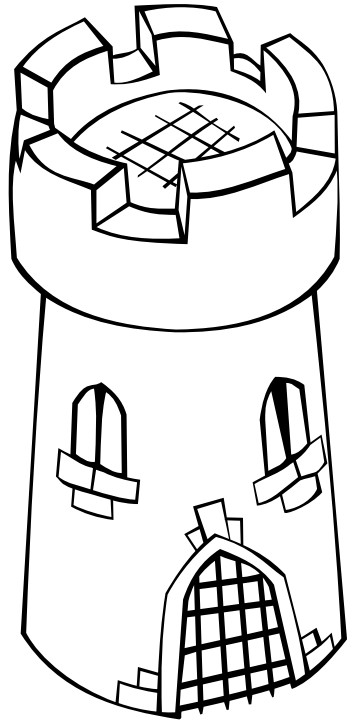

TORRE

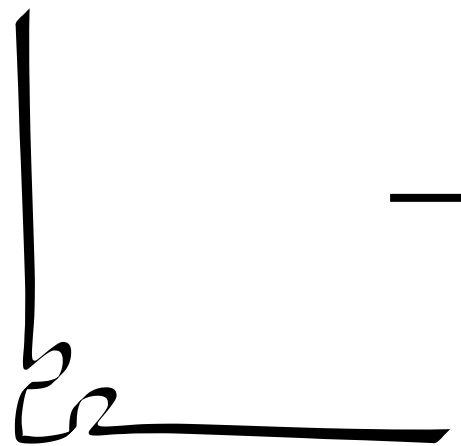
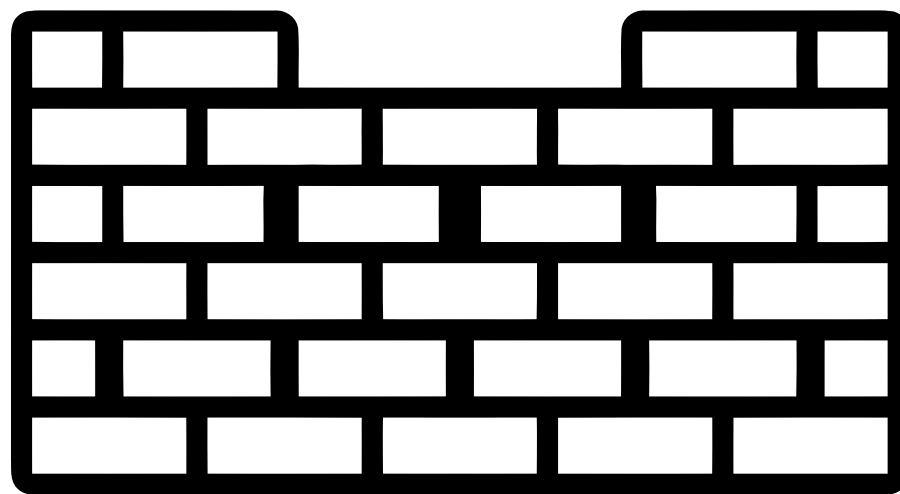
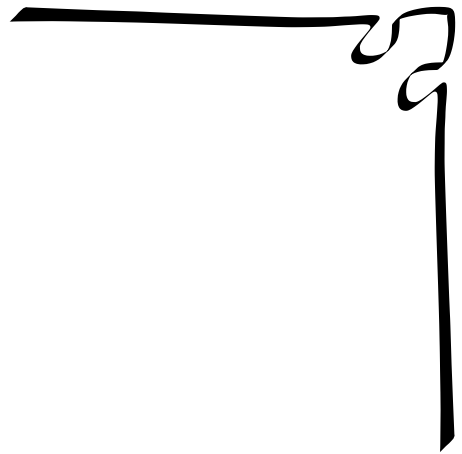

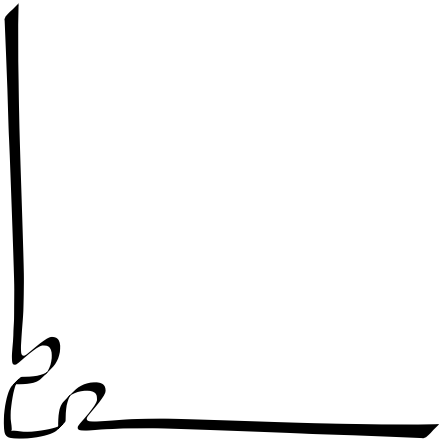
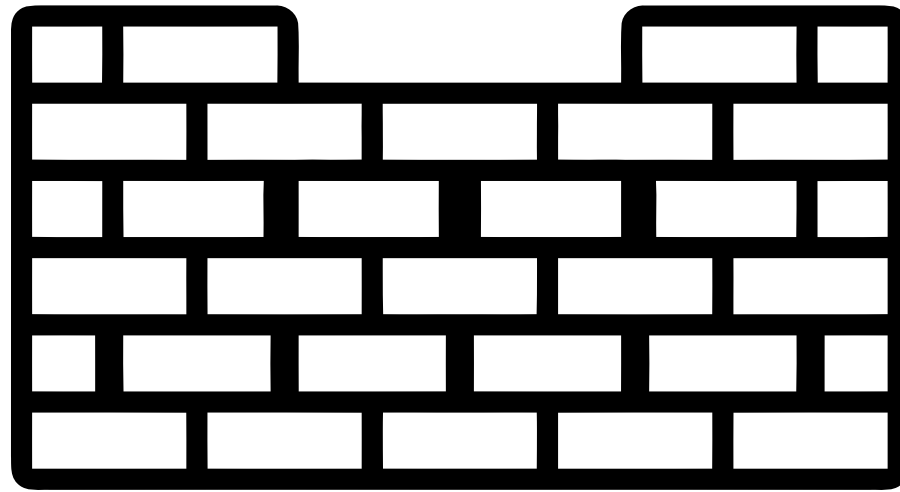

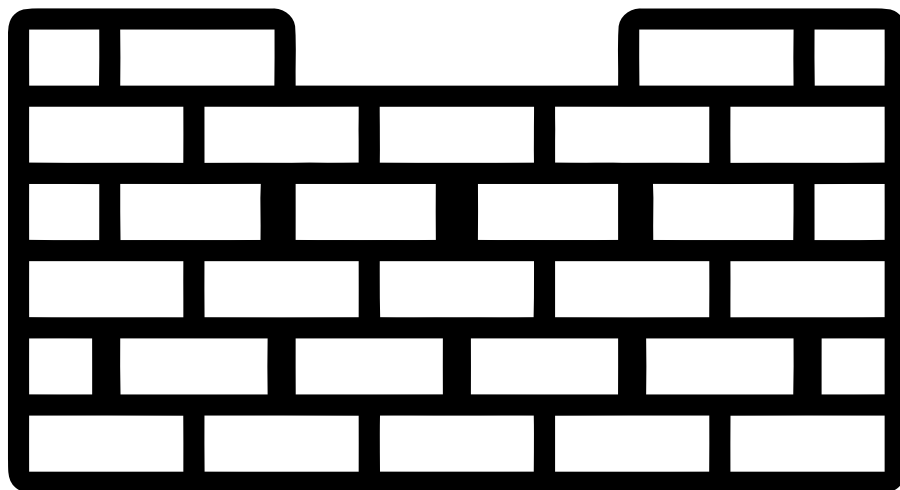

MURALLA

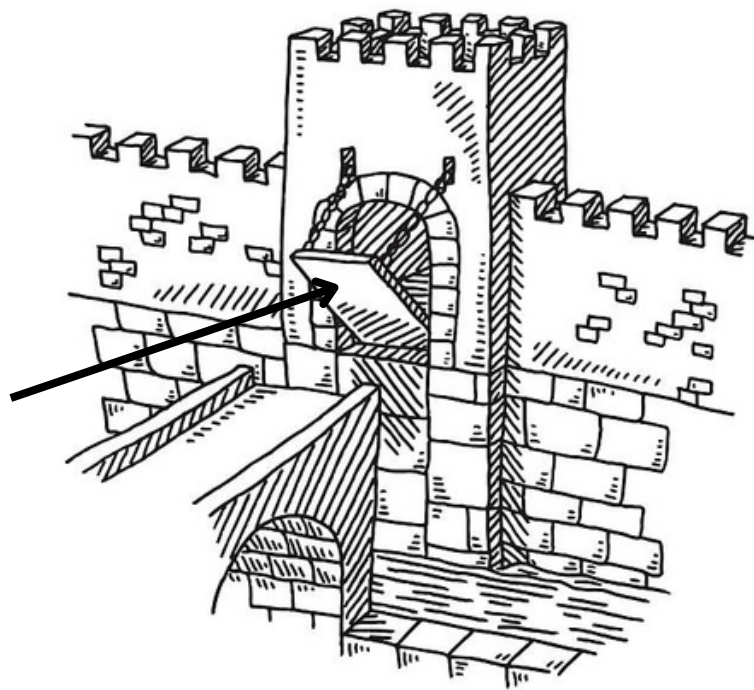

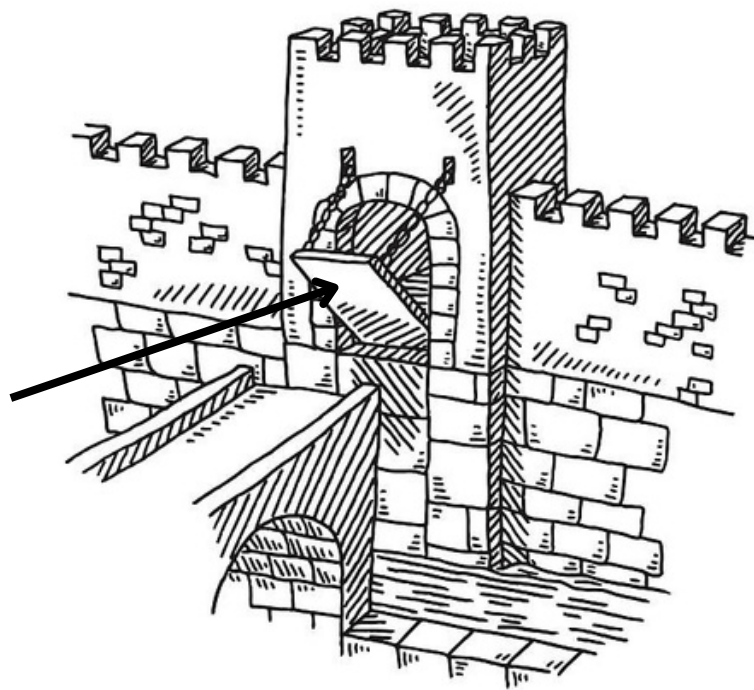

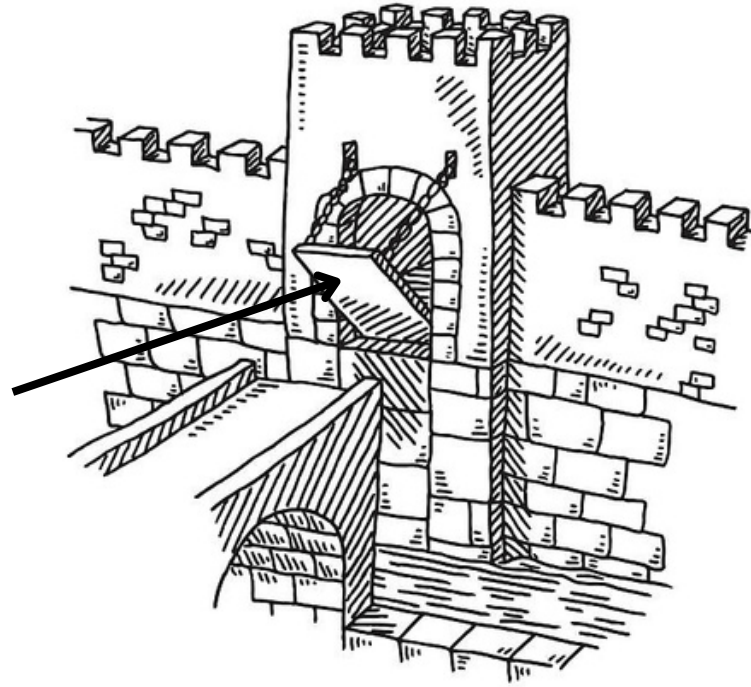

P U E N T E L E V A D O

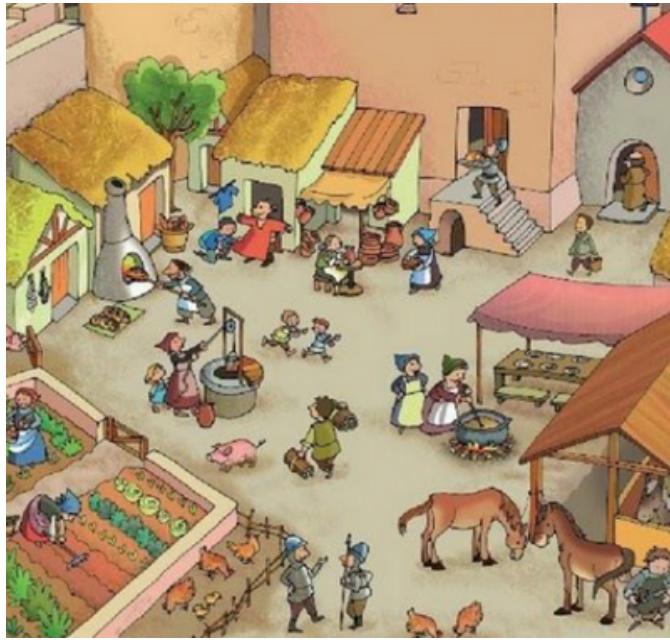



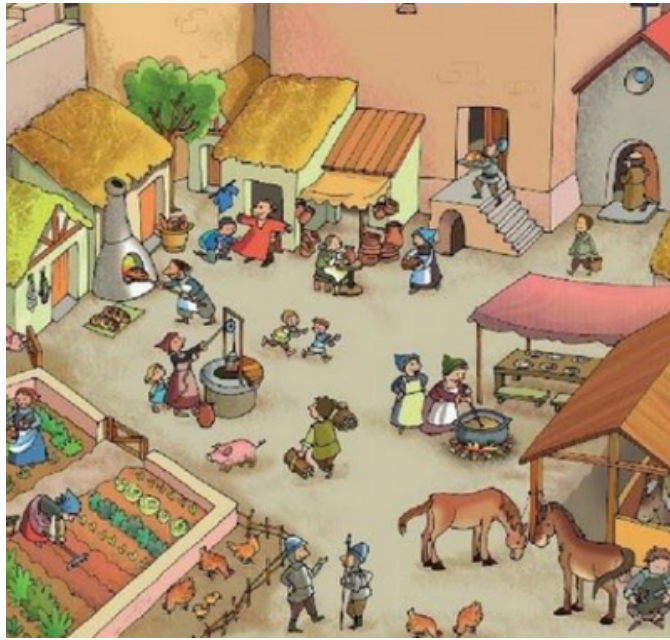



PATIO DE ARMAS

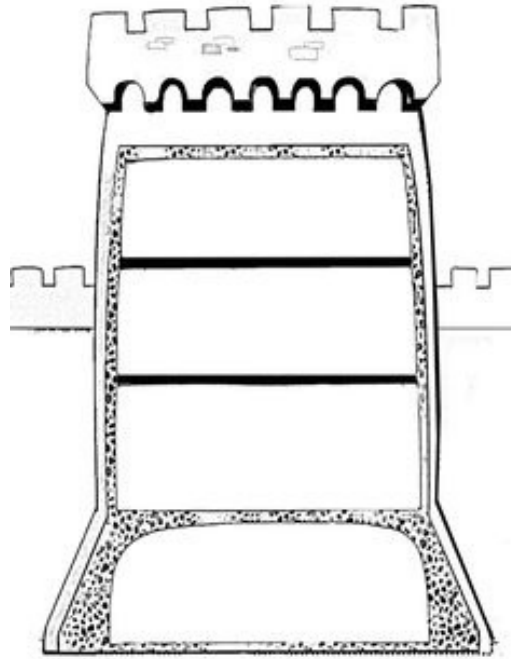

torre del homenaje

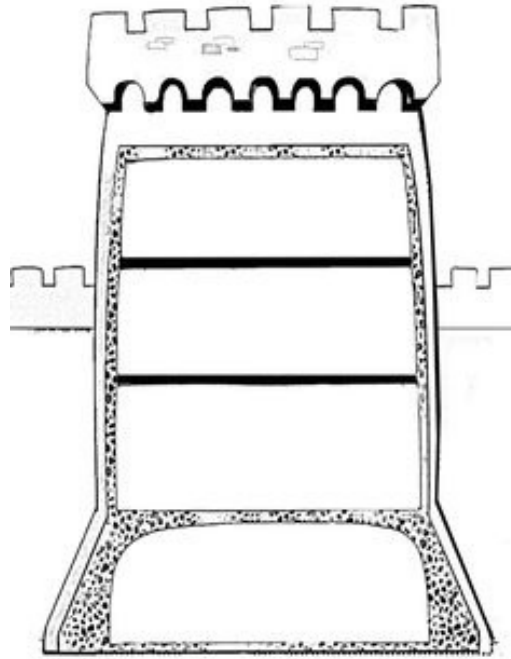

TORRE DEL HOMENAJE

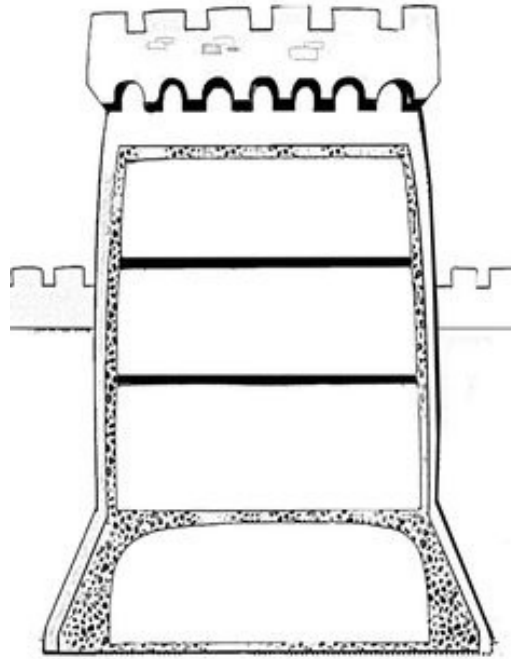

TORRE DEL
HOMENAJE

Colorear y pega las estancias de la torre del homenaje.

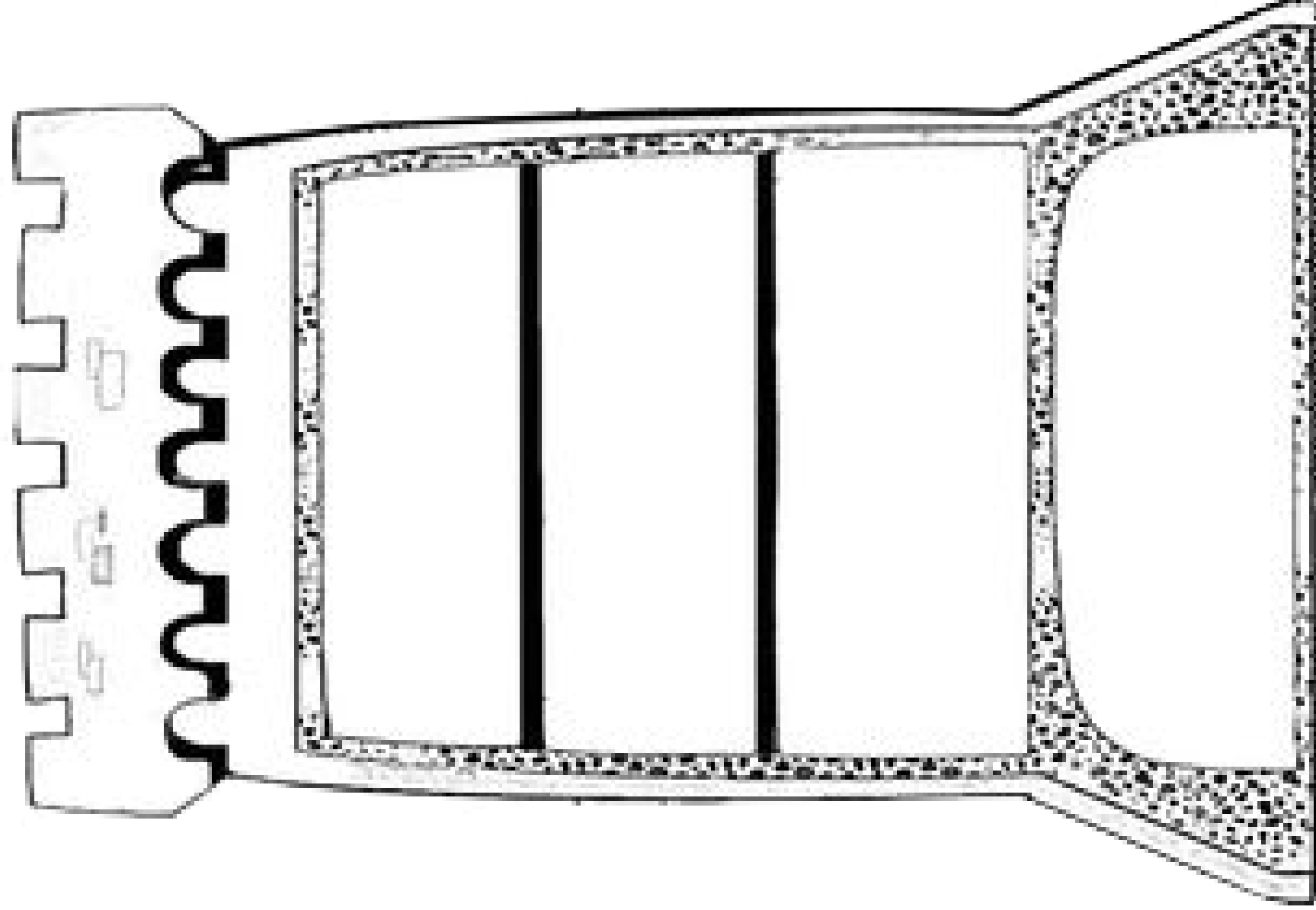

Colorear y pega las estancias de la torre del homenaje.

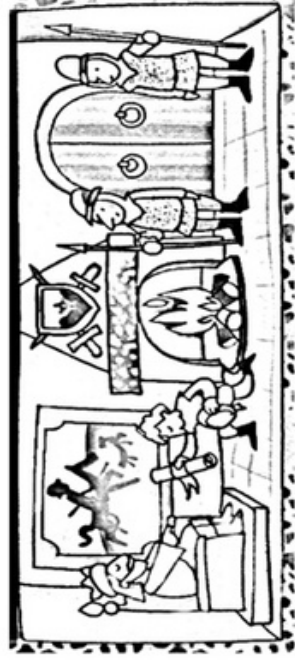
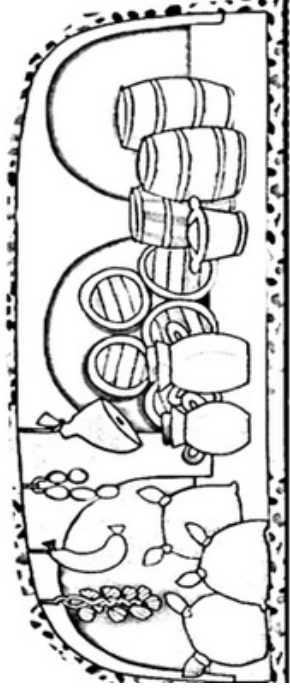
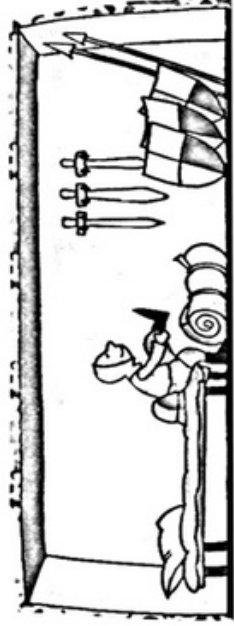
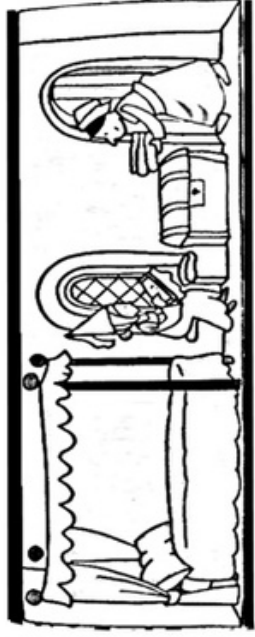

PARTES DEL CASTILLO

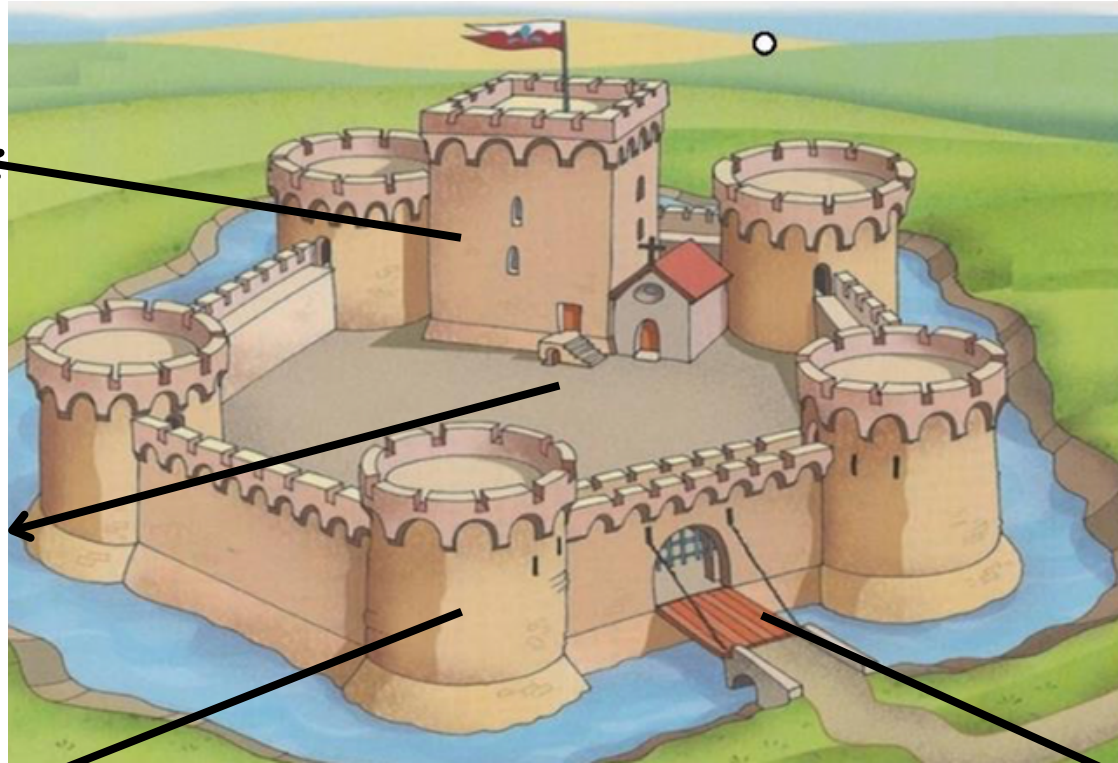

Cocinando sueños
SEÑO TERESA

TORRE HOMENAJE

TORRE GUARDIA

PATIO DE ARMAS

PUENTE LEVADIZO

PARTES DEL CASTILLO

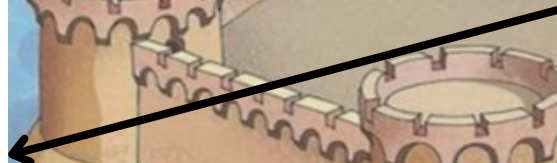
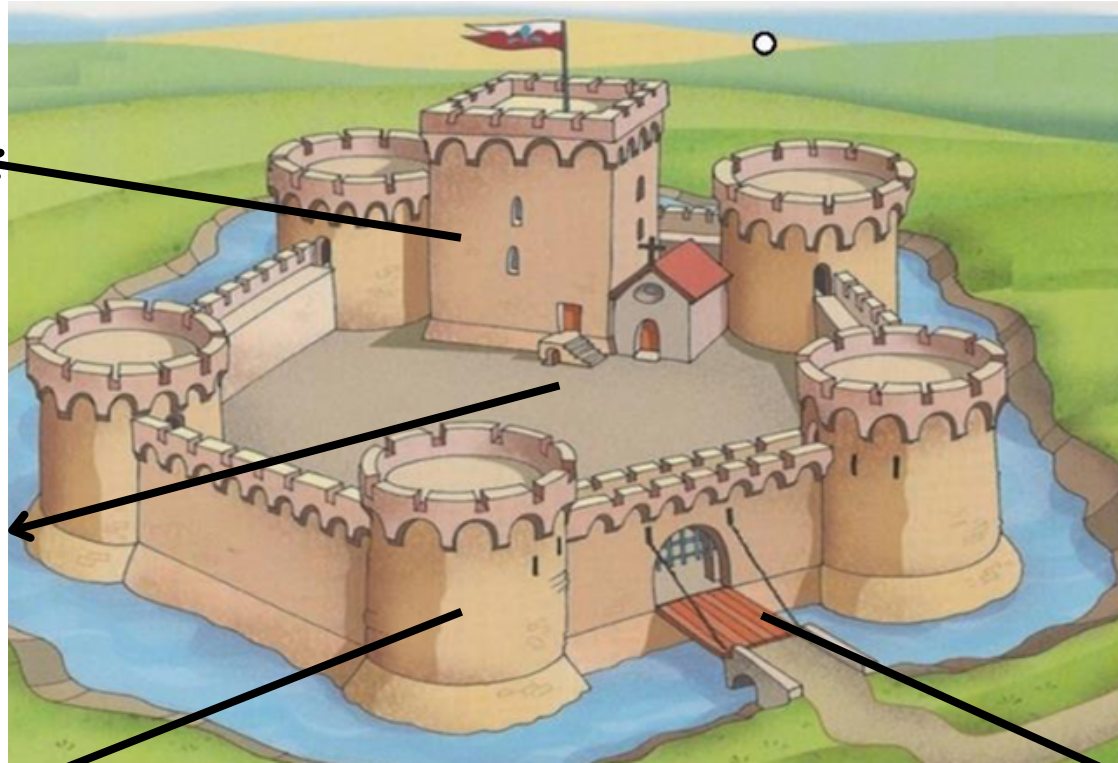

Cocinando sueños
SENOR TERESA

Torre
homenaje

Torre guardia

patis armas

Puente levadizo



Crea tu vidriera

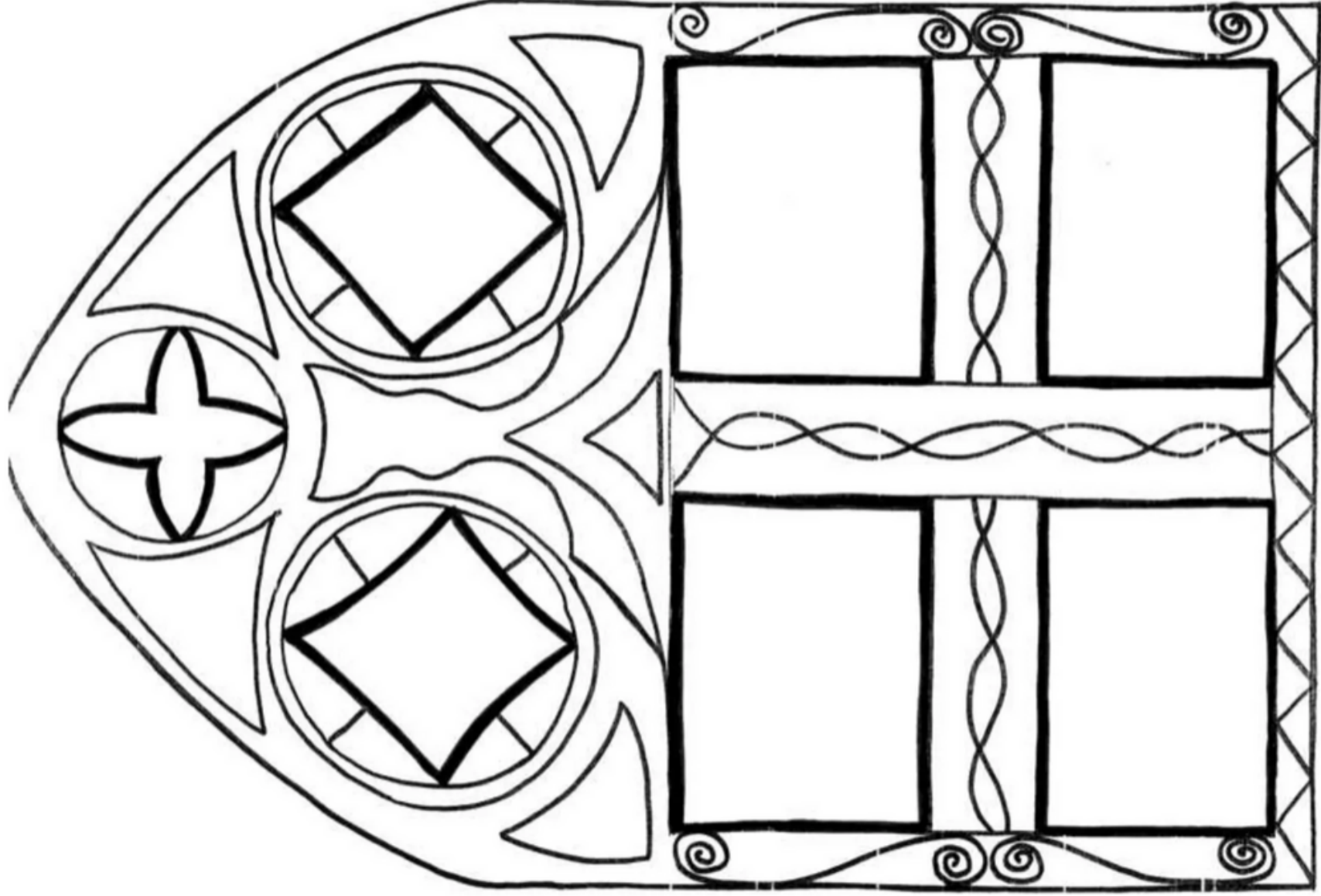

Une los puntos y descubre el castillo.

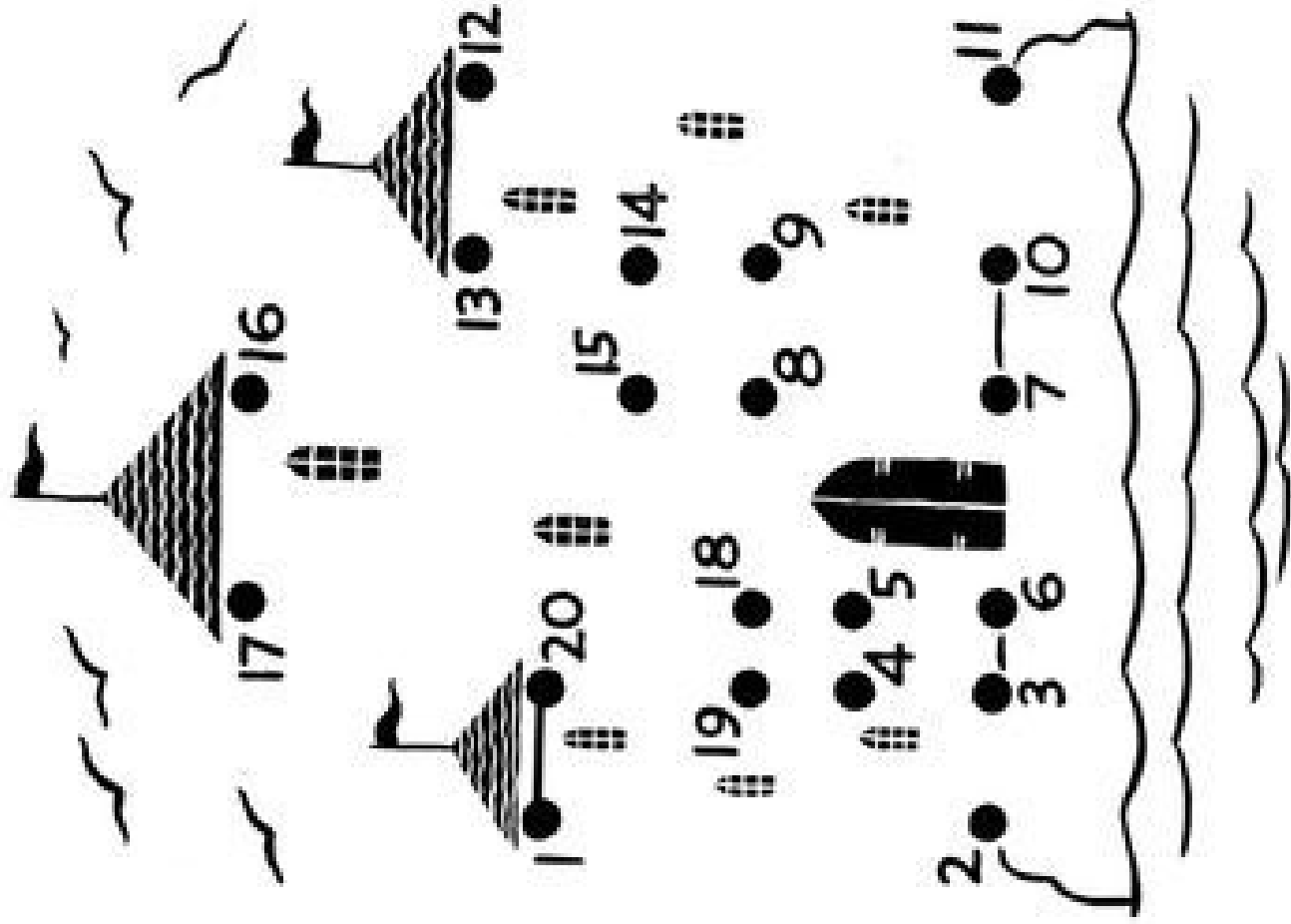

Repasa y colorea.

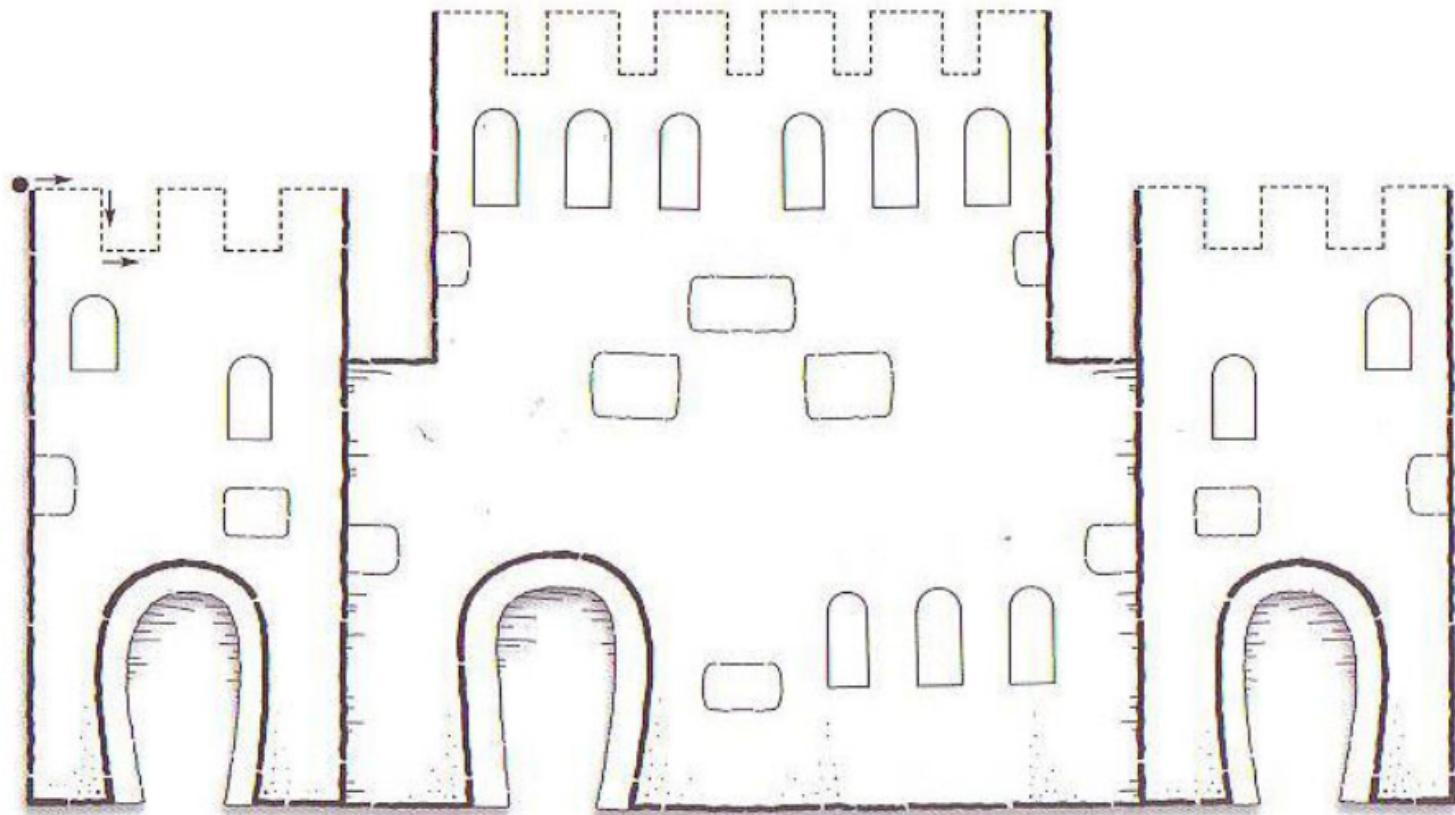
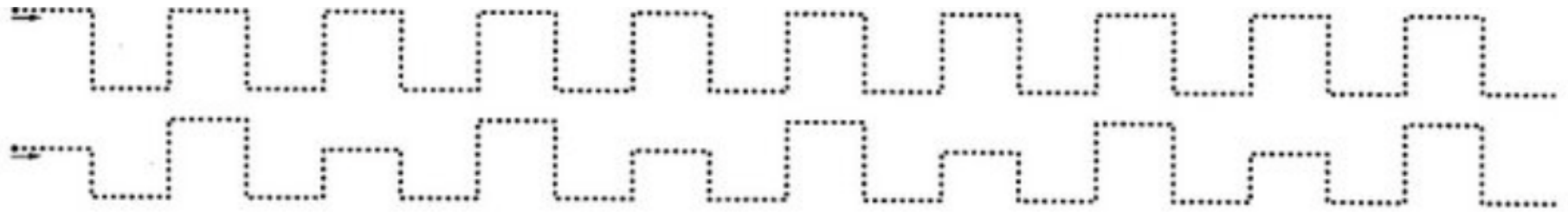

Repasa y colorea.

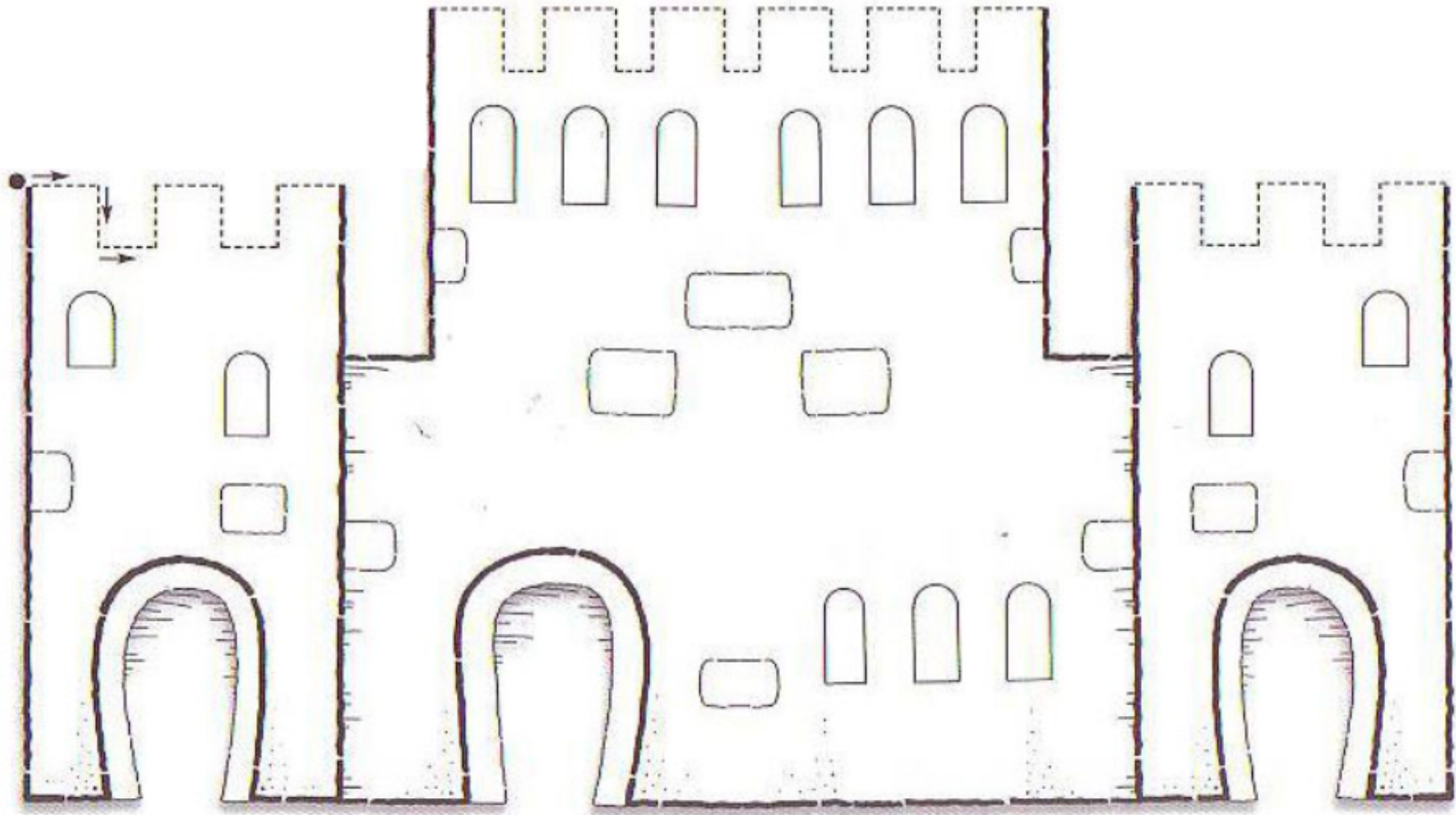

Colorea el escudo.

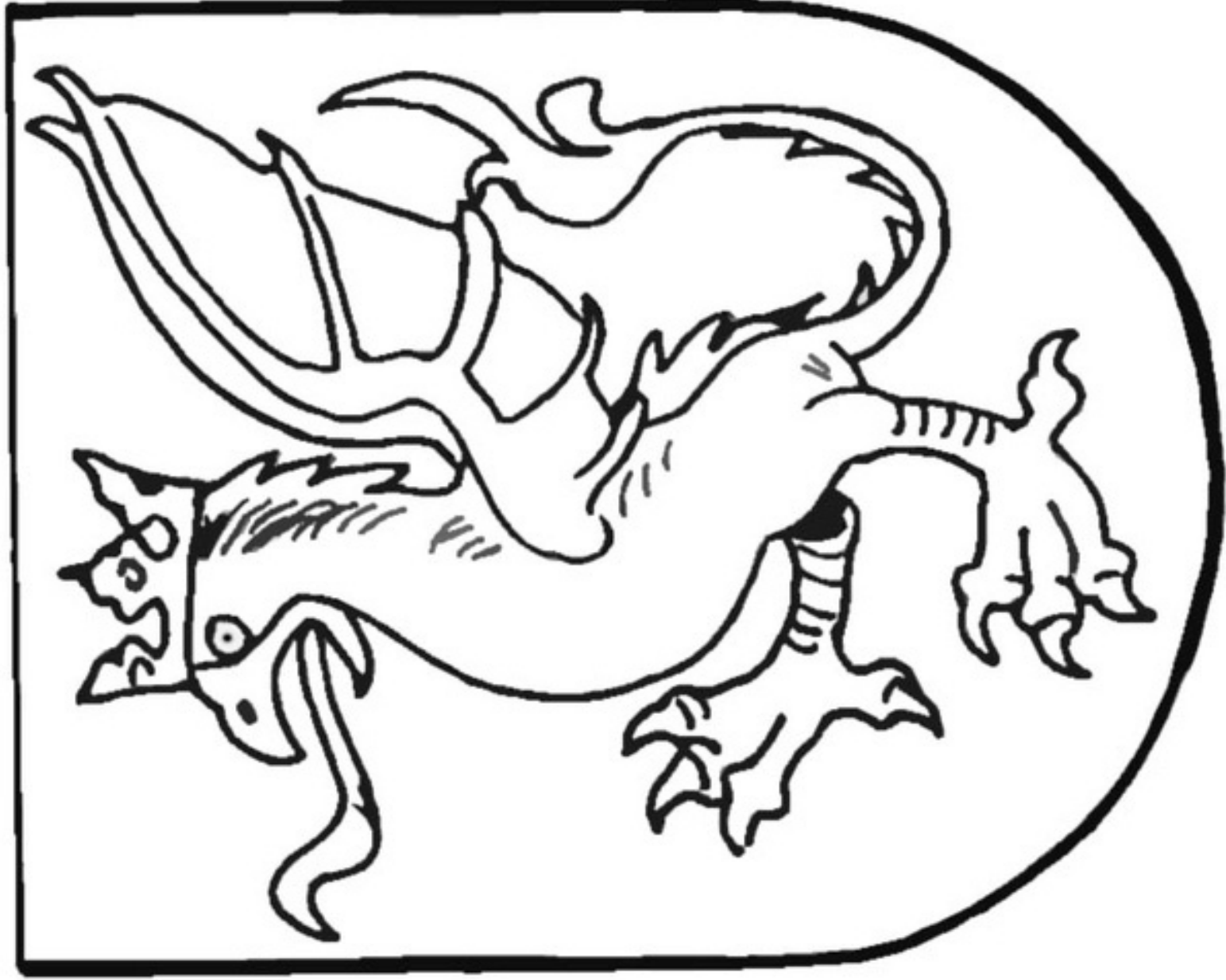

Crea tu escudo.

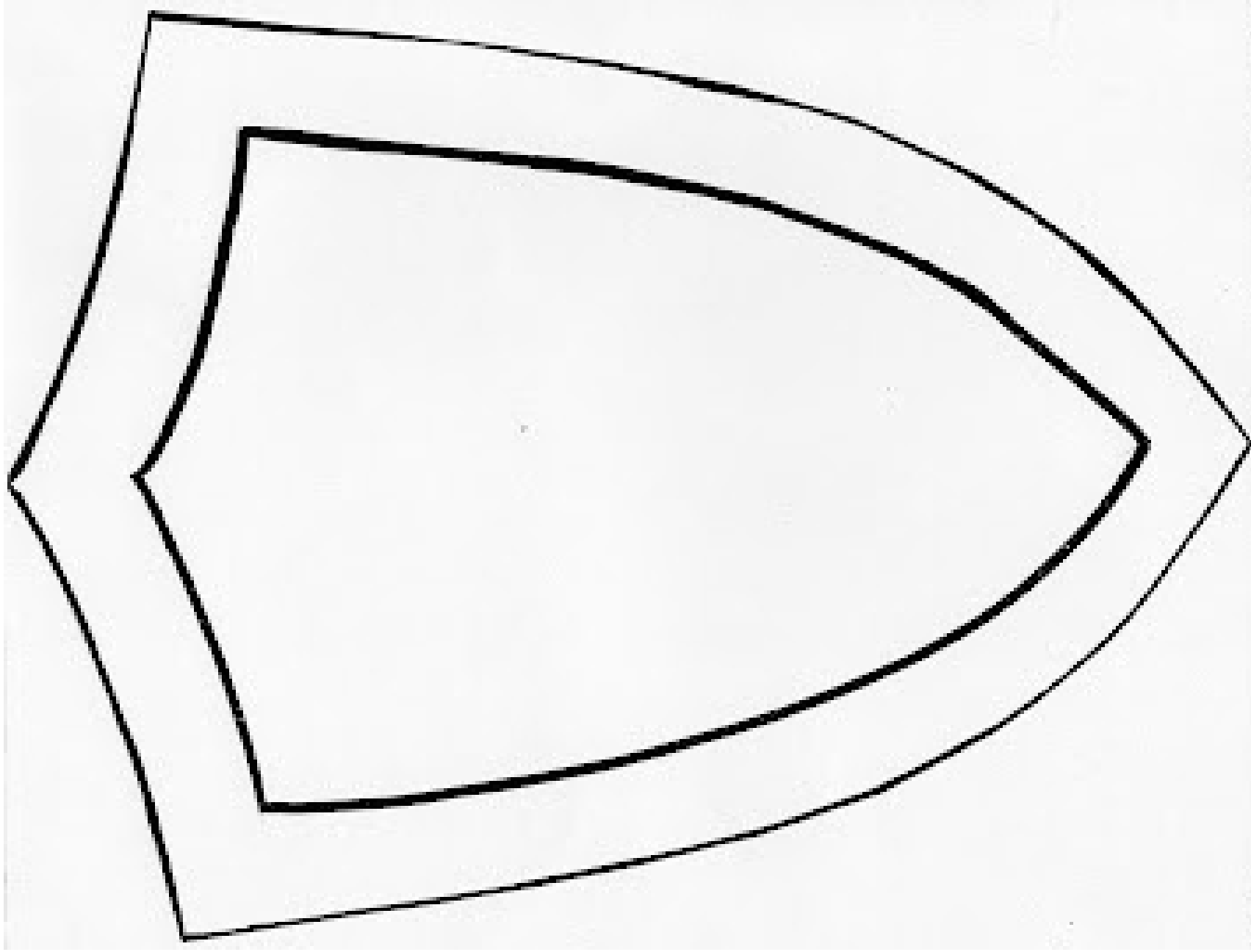

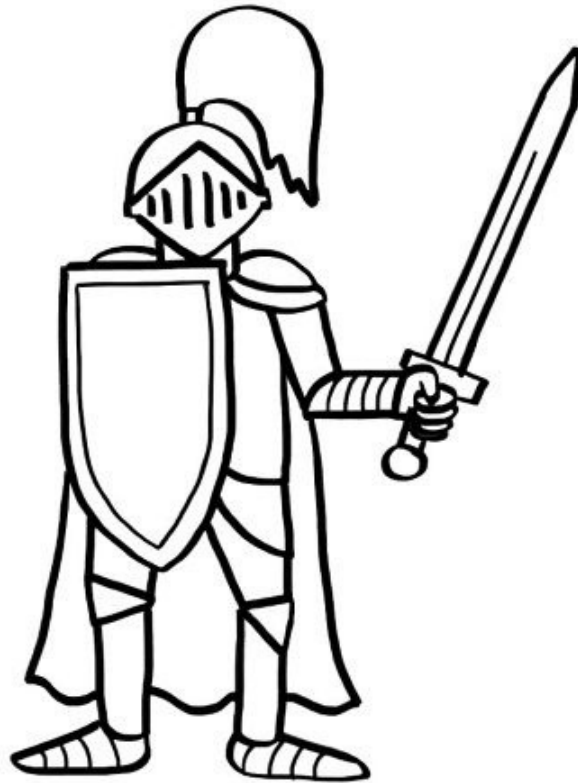



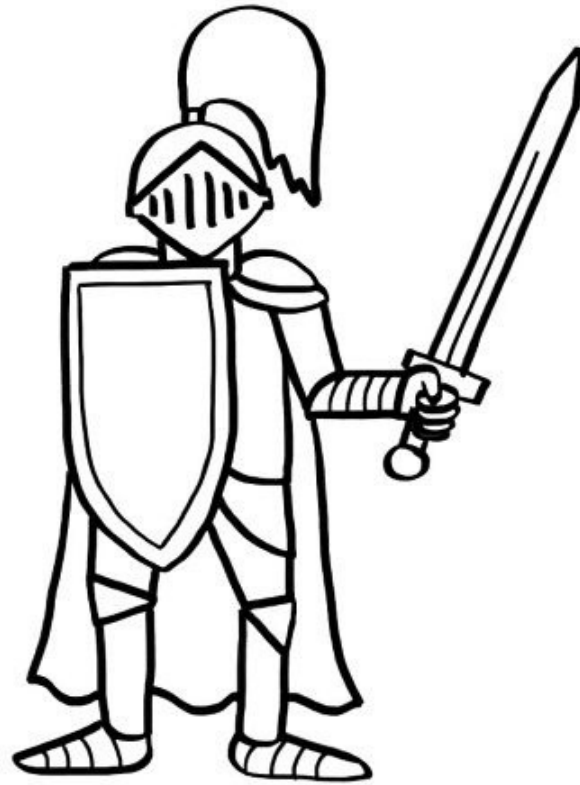

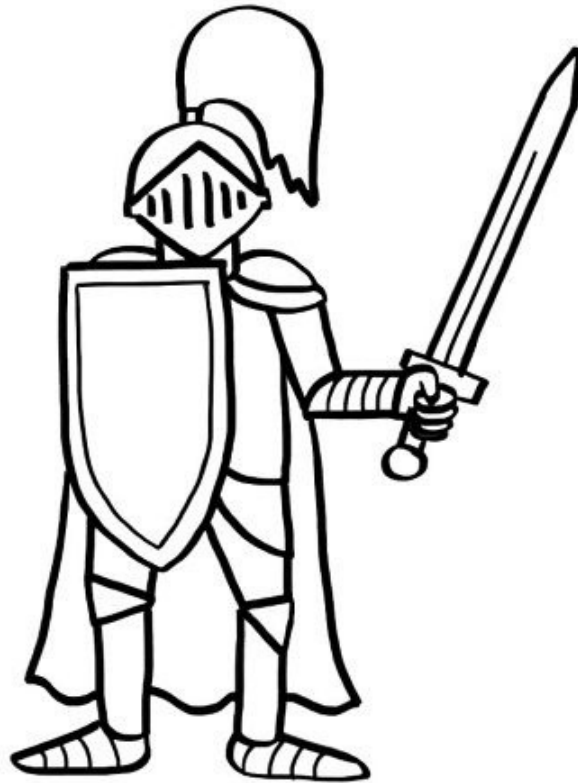

SOLDADO



JUGLAR

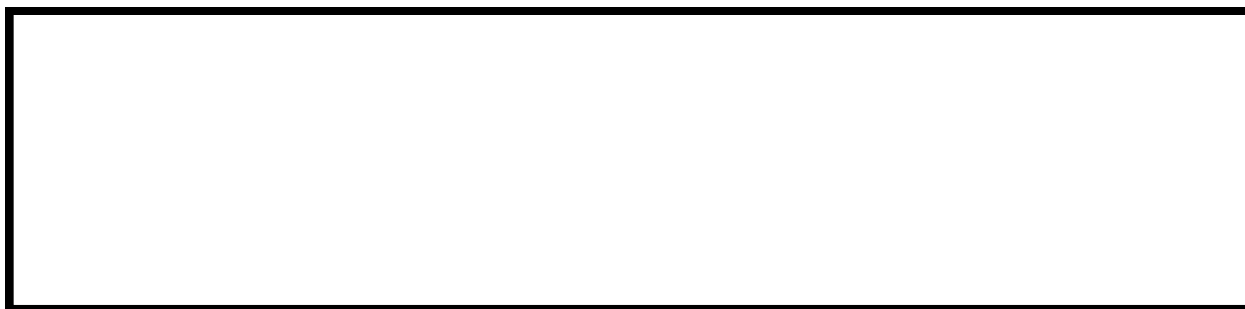

EL JUGLAR

Soy un juglar
que canta canciones
por aquí y por allá,
por todos los rincones.

Escuchad, señores,
también sé bailar,
hacer malabares
e historias contar.



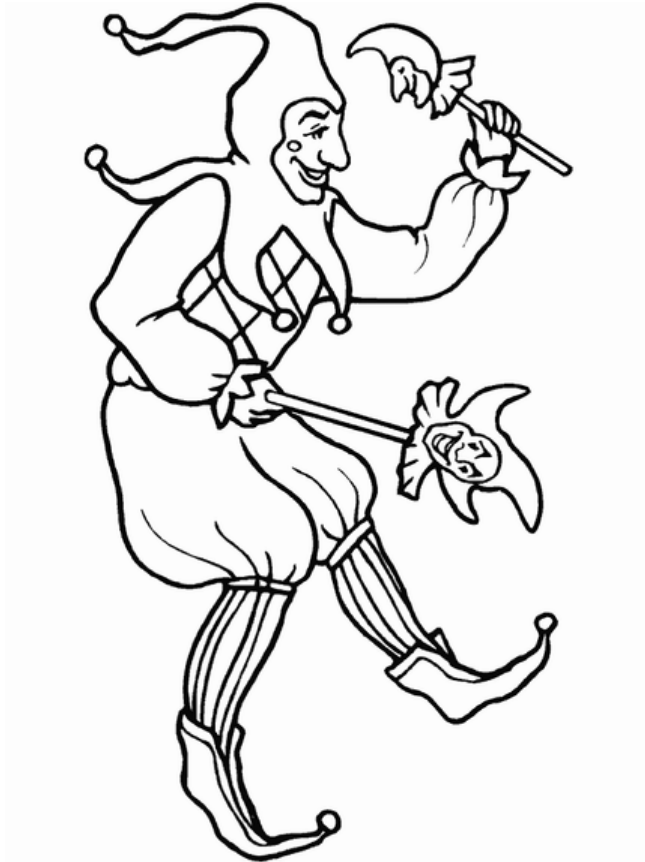

BUFÓN

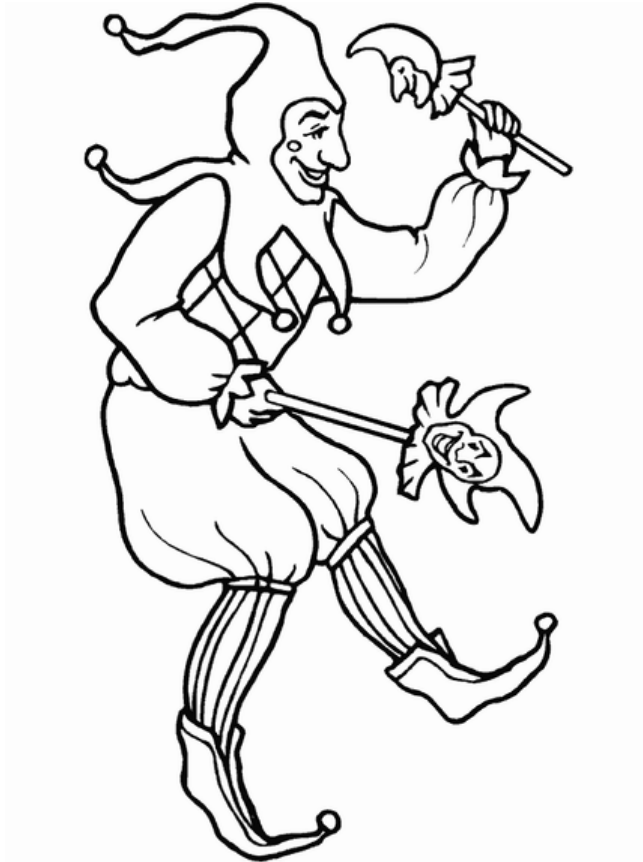

Cocinando sueños
SEÑO TERESA

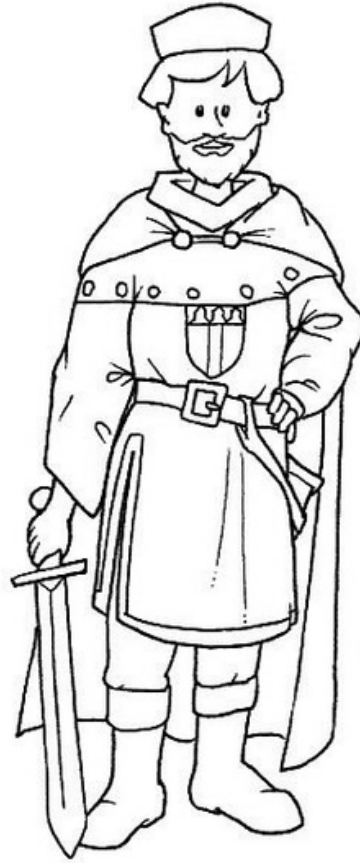

CABALLERO

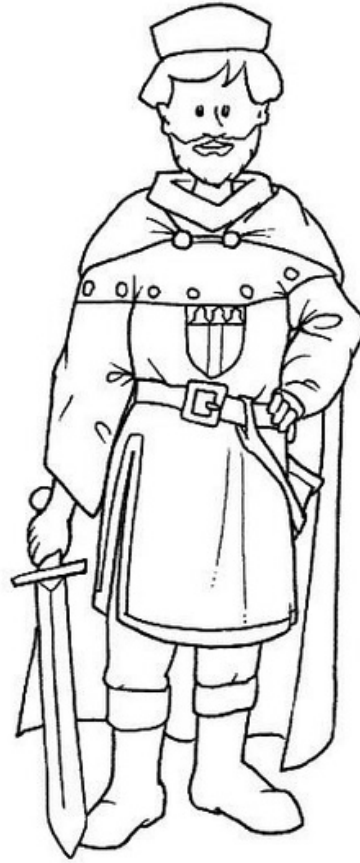

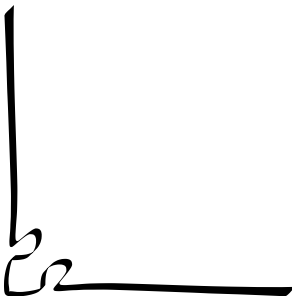
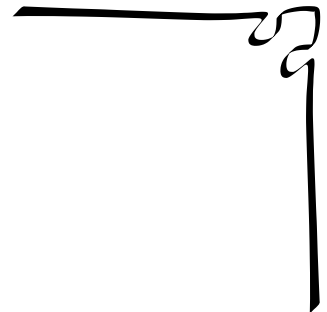
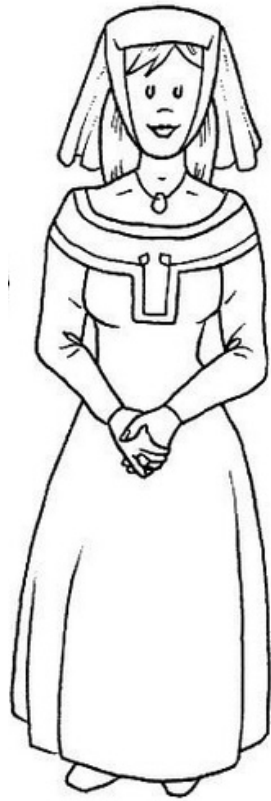

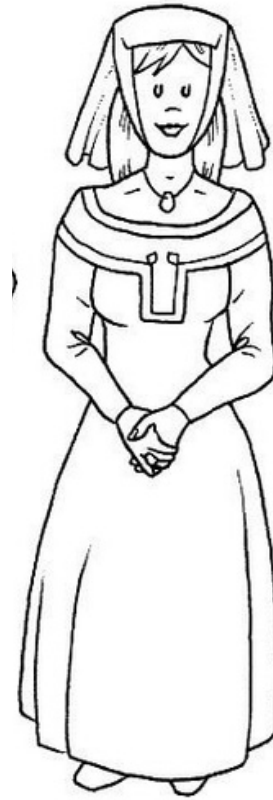

DAMA



Cocinando sueños
SEÑO TERESA



HERREDO



SENORES

LOS ARTESANOS

PANADERO



CARPINTERO



SASTRE



HERRERO



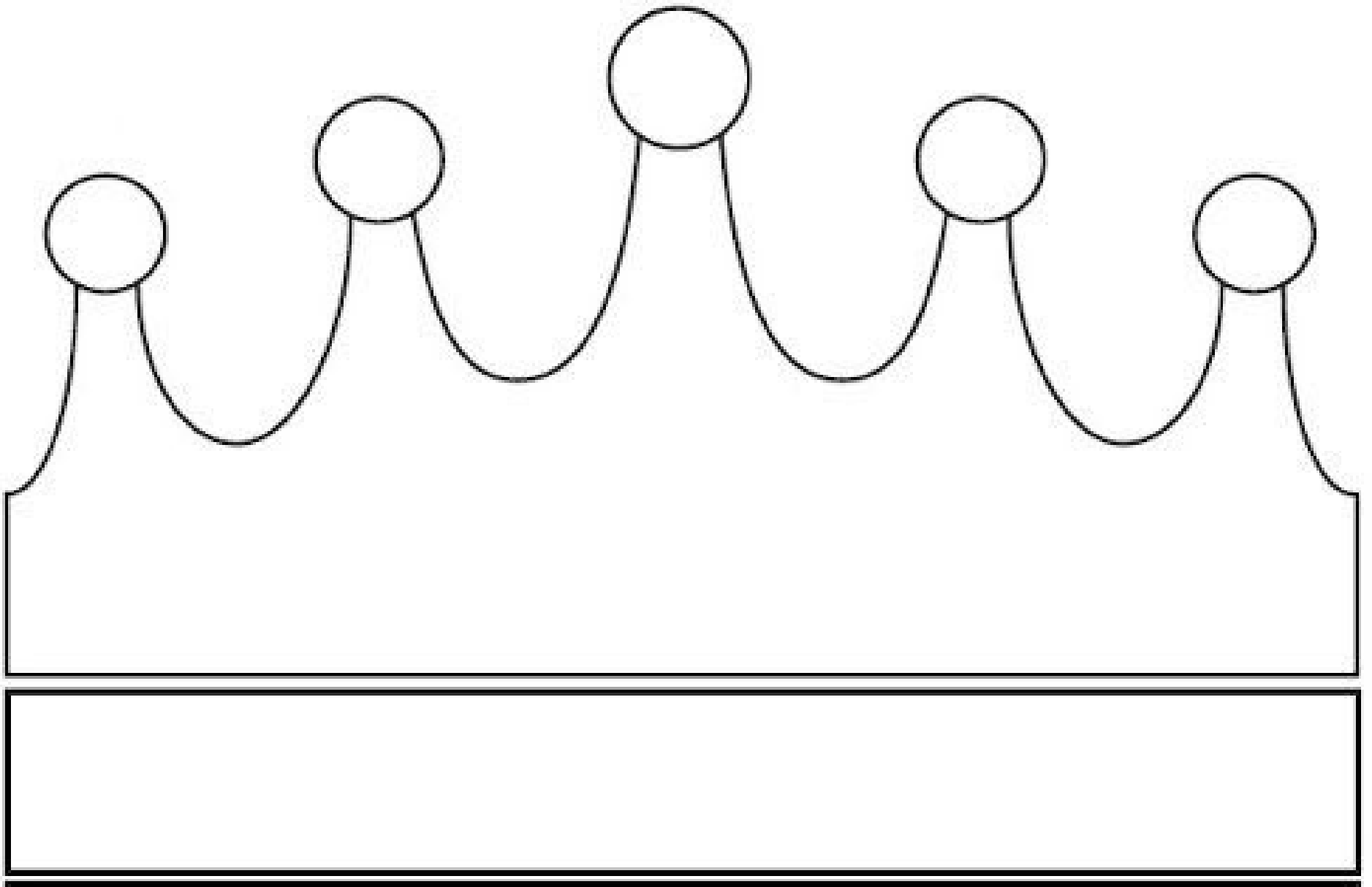

Dibuja a los señores del castillo.

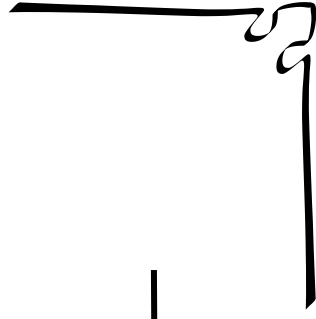
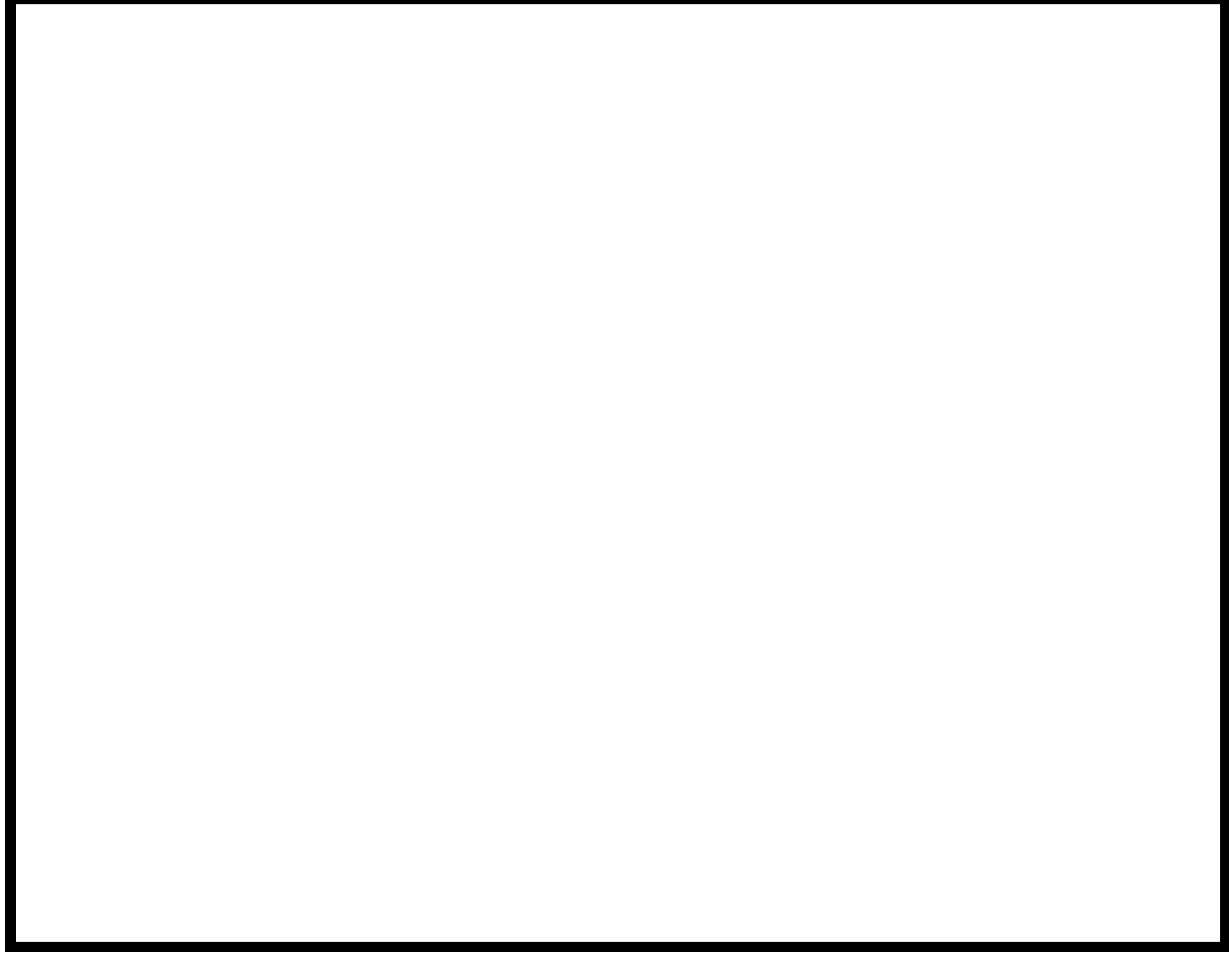

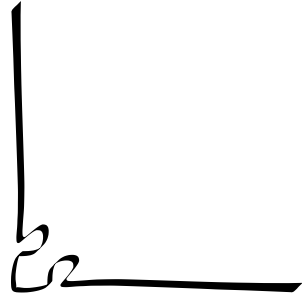

Coloca las partes de la armadura.

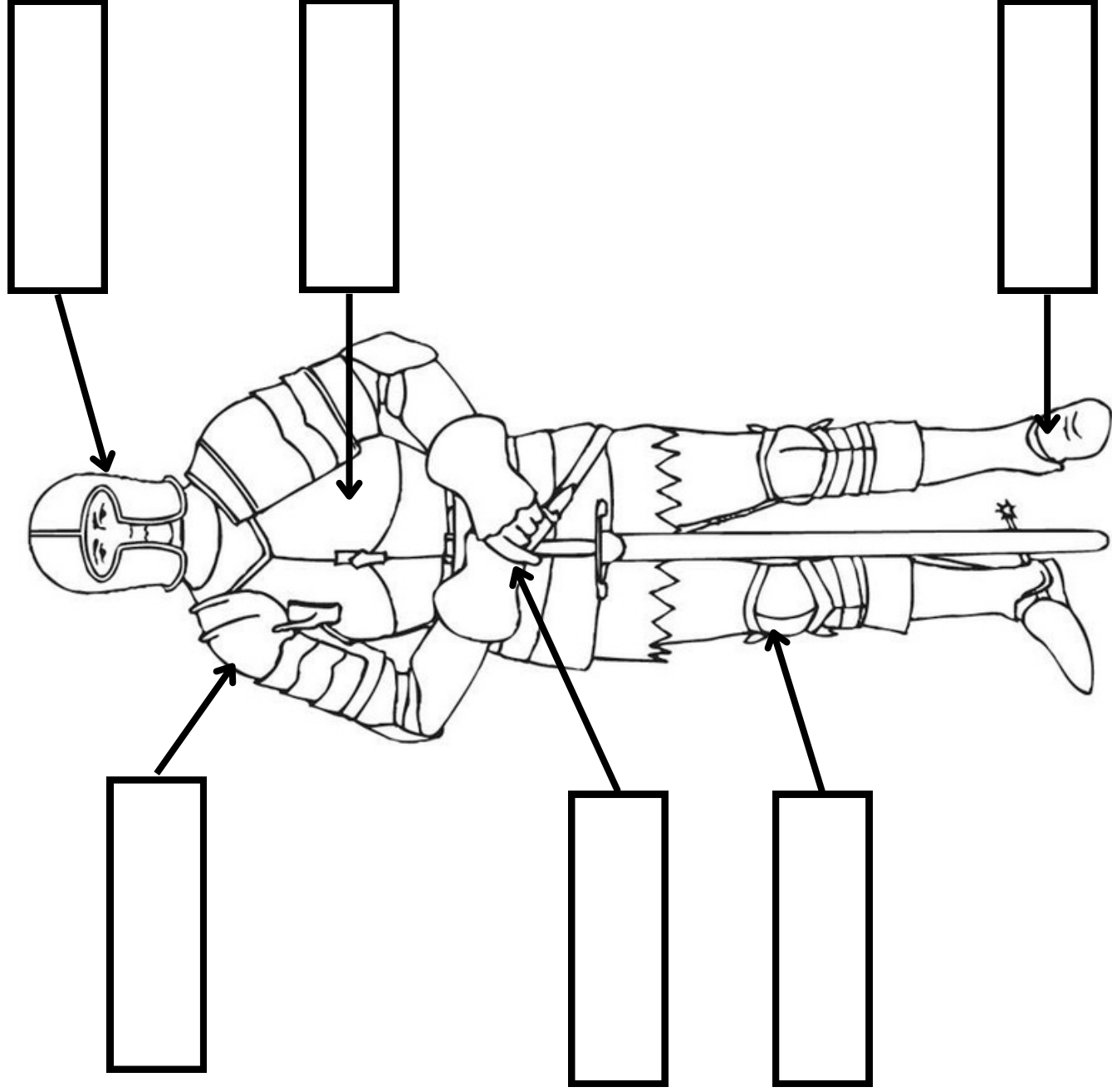

Cocinando sueños
SENO TERESA

YELMO

PETO

RODILLERA

MANOPLA

HOMBRERA

ESCARPE

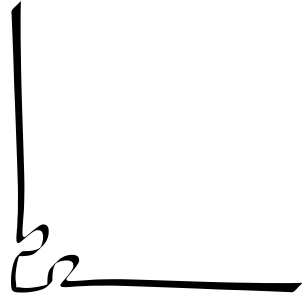

Coloca las partes de la armadura.

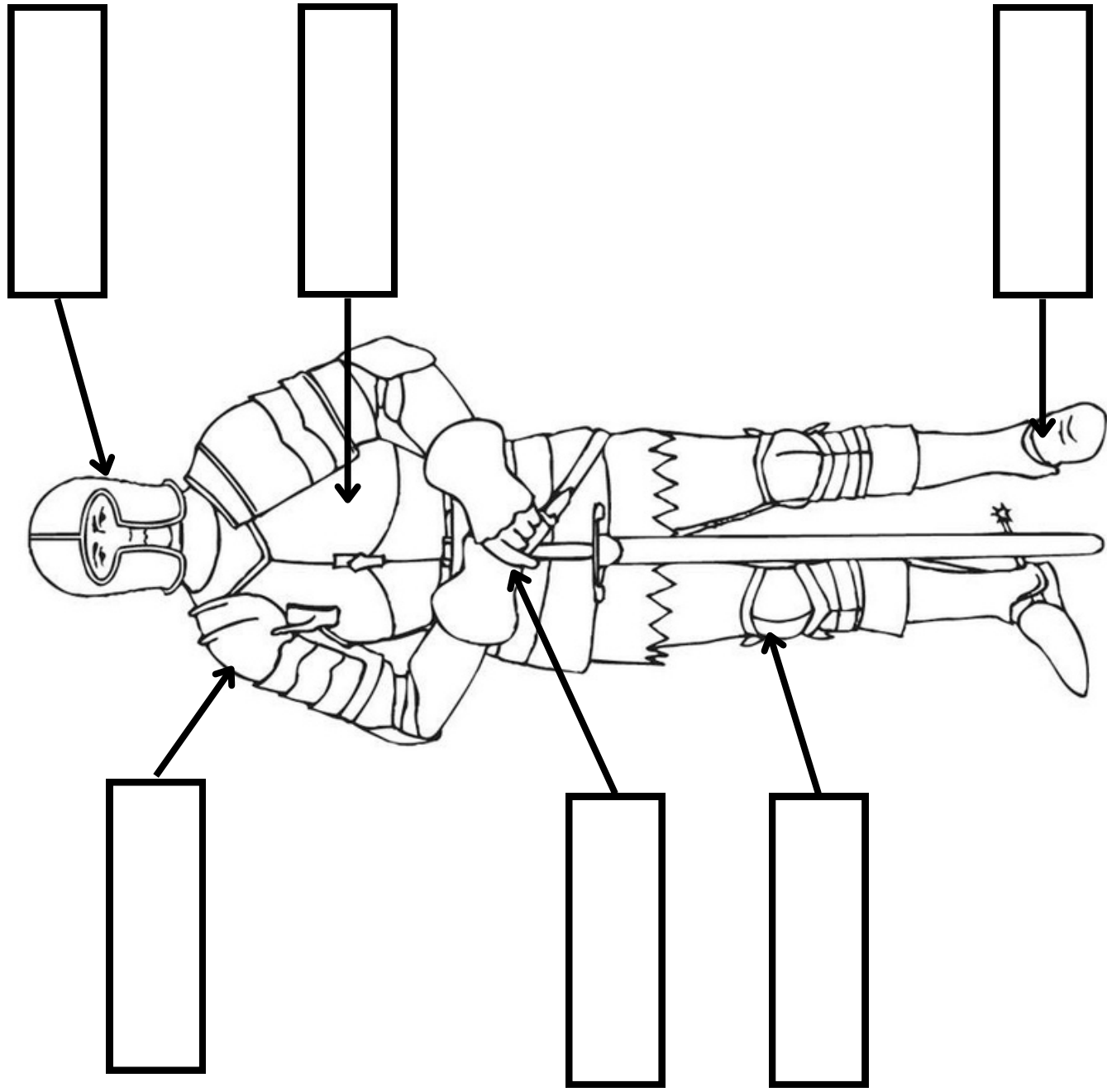

Cocinando sueños
SENO TERESA

Yelmo

Peto

Rodillera

Manopla

Hombreira

Escarpe



Castillo de San Juan de los Terreros

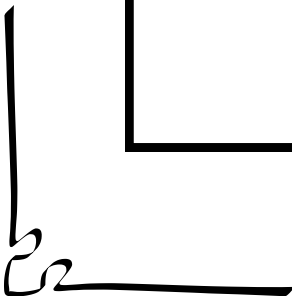

Realiza un dibujo del castillo.

CASTILLOS DE ANDALUCÍA

Castillo de San Juan de los Terreros



- Es una fortaleza.
- Se construye sobre la cima de una colina.

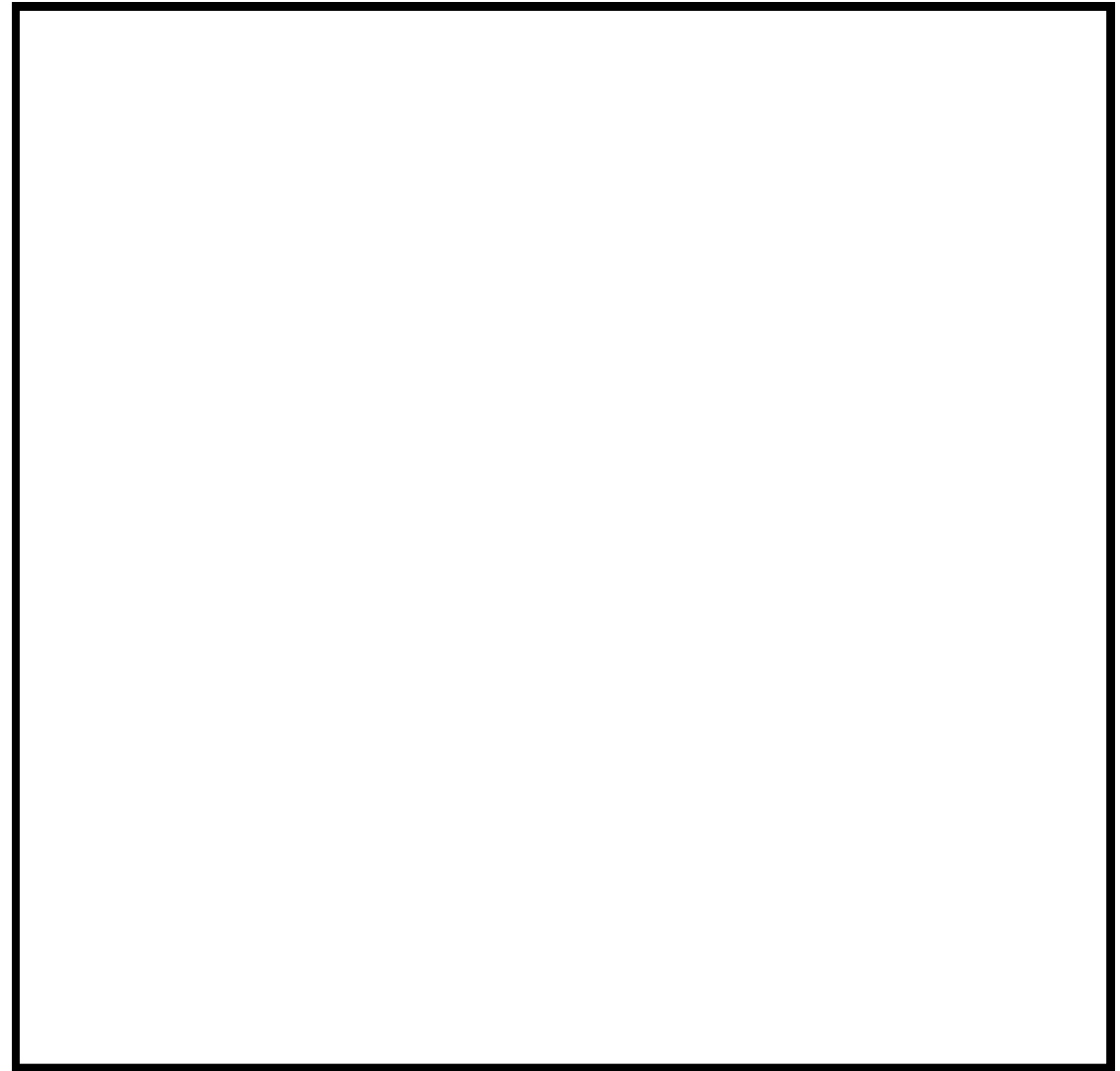

Realiza un dibujo del castillo.

CASTILLOS DE ANDALUCÍA

Castillo de Veléz Blanco



- Construido en el siglo XVI.
- Estilo renacentista.
- Se construye sobre una mezquita en el cerro que domina la villa.

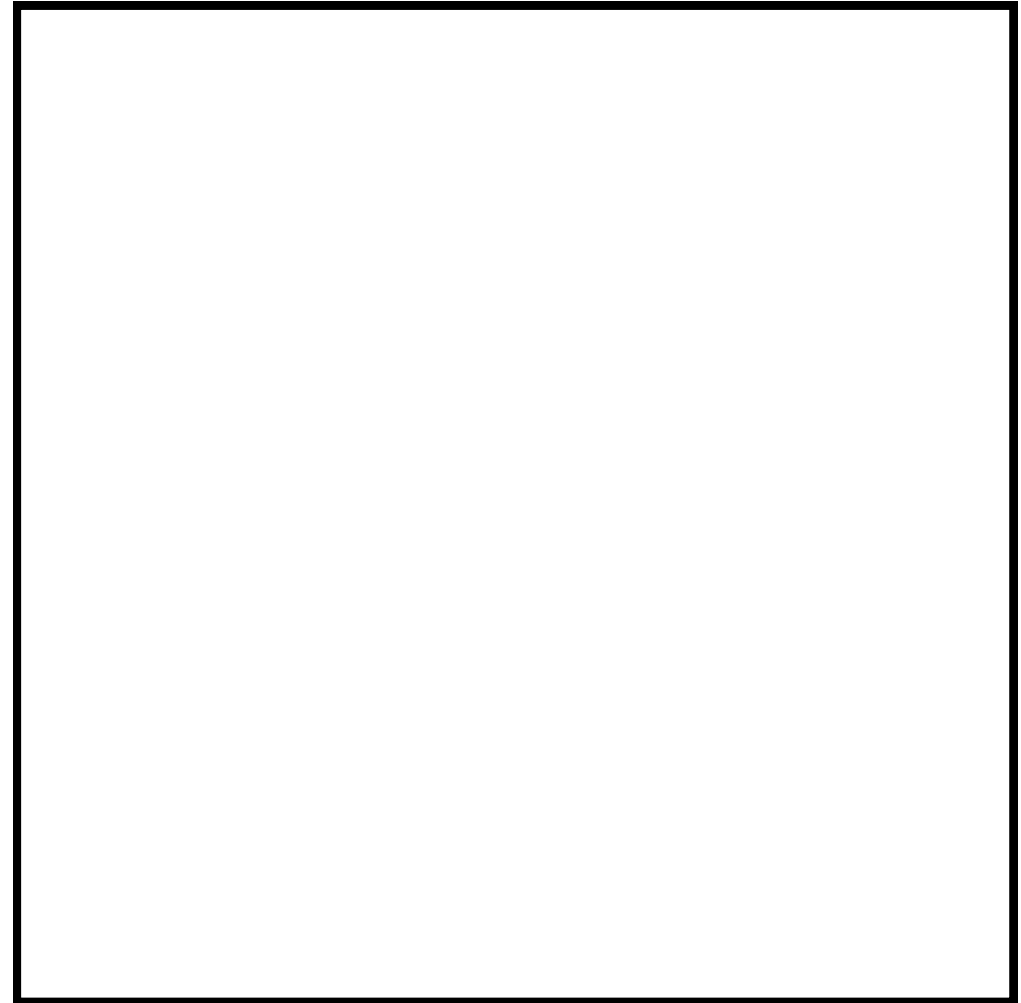

Realiza un dibujo del castillo.

CASTILLOS DE ANDALUCÍA

Castillo de Belalcázar (Córdoba)



- Construido en el siglo XV.
- Perteneciente a los condes de Belalcázar.
- Da nombre a la población.

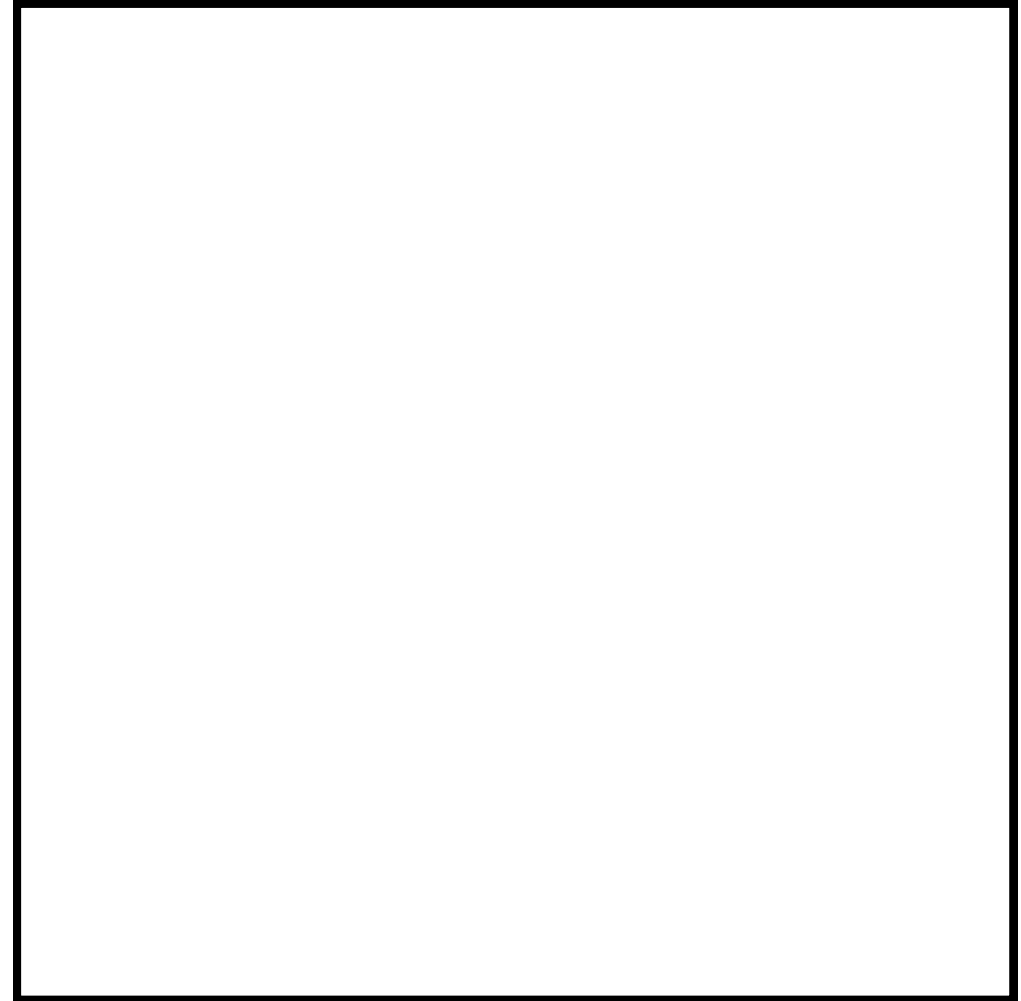

Realiza un dibujo del castillo.

CASTILLOS DE ANDALUCÍA

Castillo de Baños de la Encina (Jaén)



- Construido en el siglo X.
- Fortaleza musulmana.
- Se construye sobre una una colina rocosa.

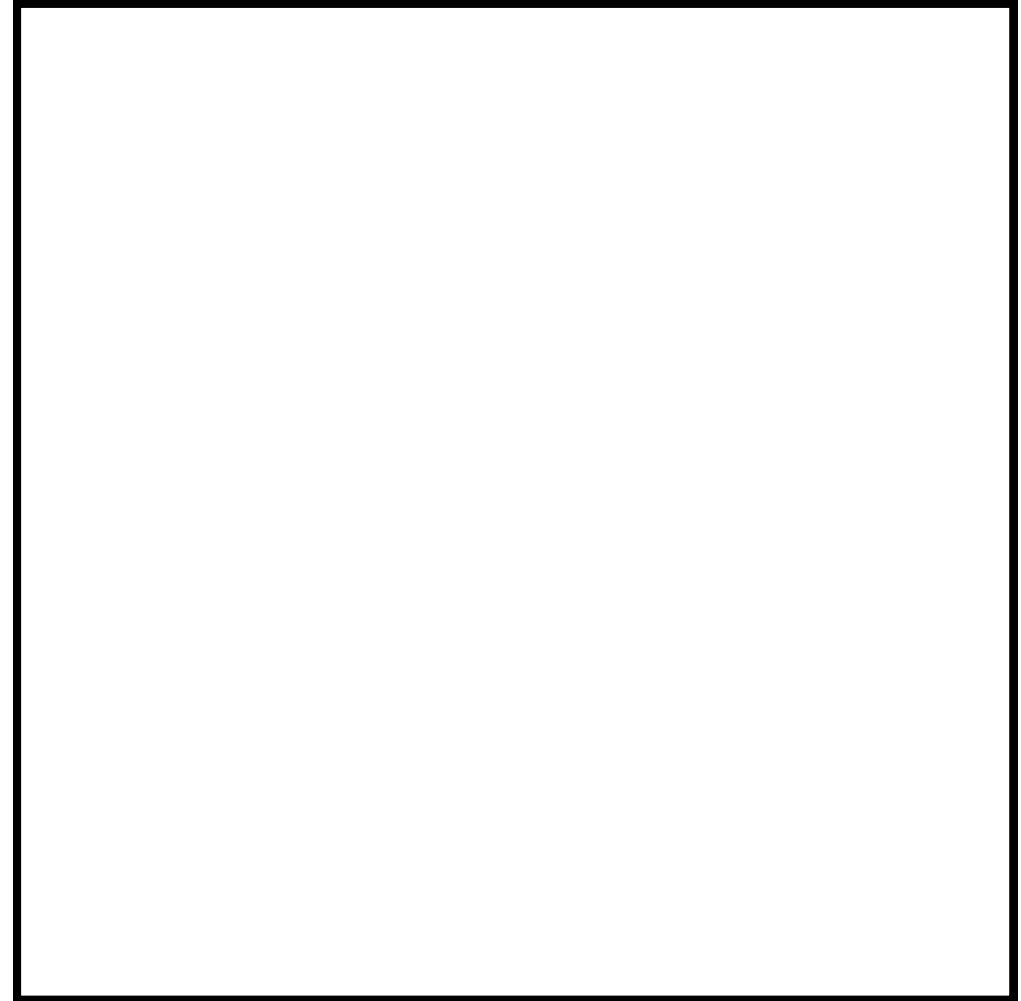

Realiza un dibujo del castillo.

LA PLAZA

La plaza tiene una torre,
la torre tiene un balcón.

El balcón tiene una dama,
la dama una blanca flor.

Allí pasó un caballero,
¿quién sabe por qué pasó?

y se ha llevado la plaza,
la plaza con su balcón,
con su balcón y su dama,
su dama y su blanca flor.

ANTONIO MACHADO

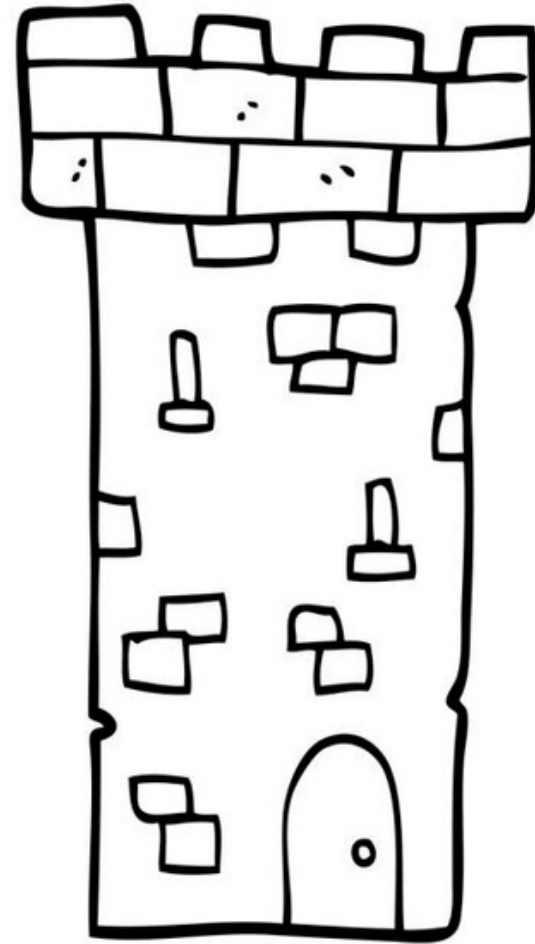

LA PLAZA

LA PLAZA TIENE UNA TORRE,
LA TORRE TIENE UN BALCÓN.
EL BALCÓN TIENE UNA DAMA,
LA DAMA UNA BLANCA FLOR.

ALLÍ PASÓ UN CABALLERO,
¿QUIÉN SABE POR QUÉ PASÓ?

Y SE HA LLEVADO LA PLAZA,
LA PLAZA CON SU BALCÓN,
CON SU BALCÓN Y SU DAMA,
SU DAMA Y SU BLANCA FLOR.

ANTONIO MACHADO

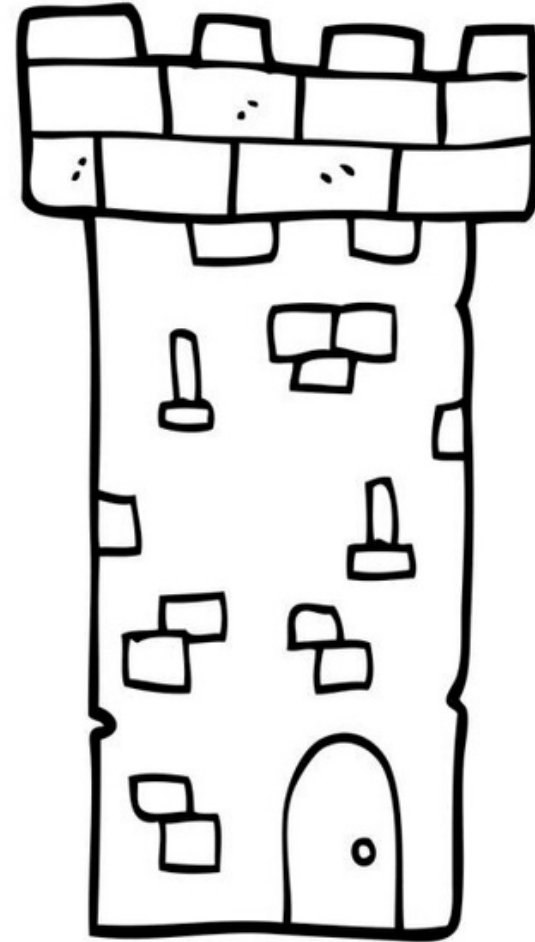

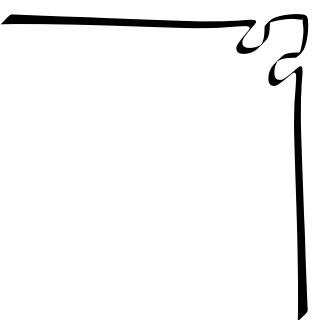
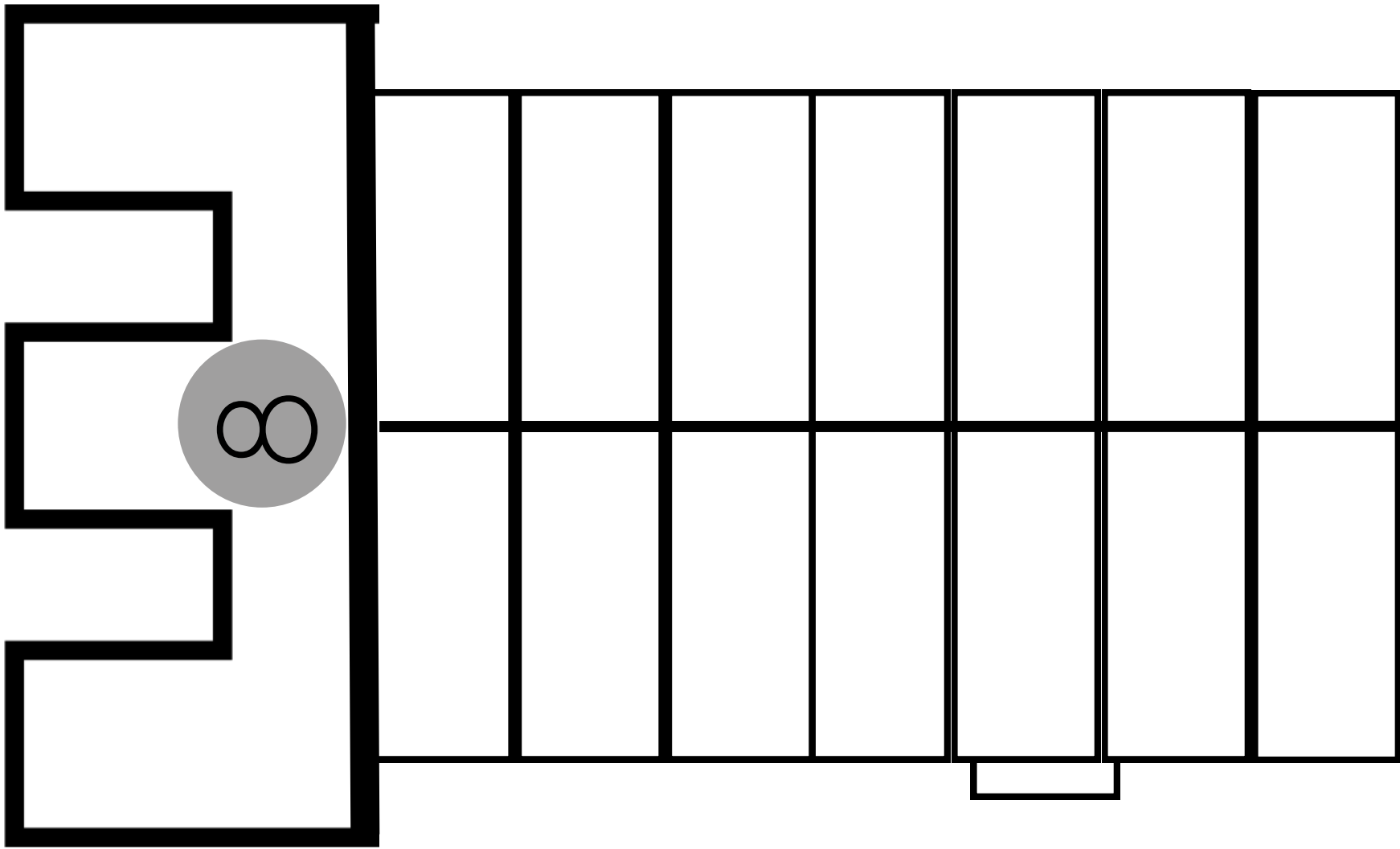
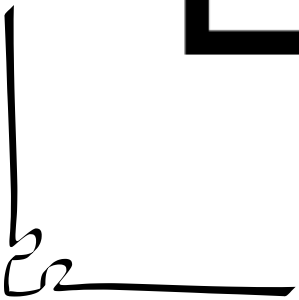

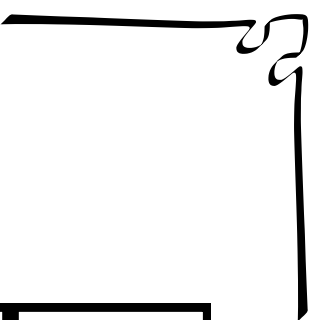
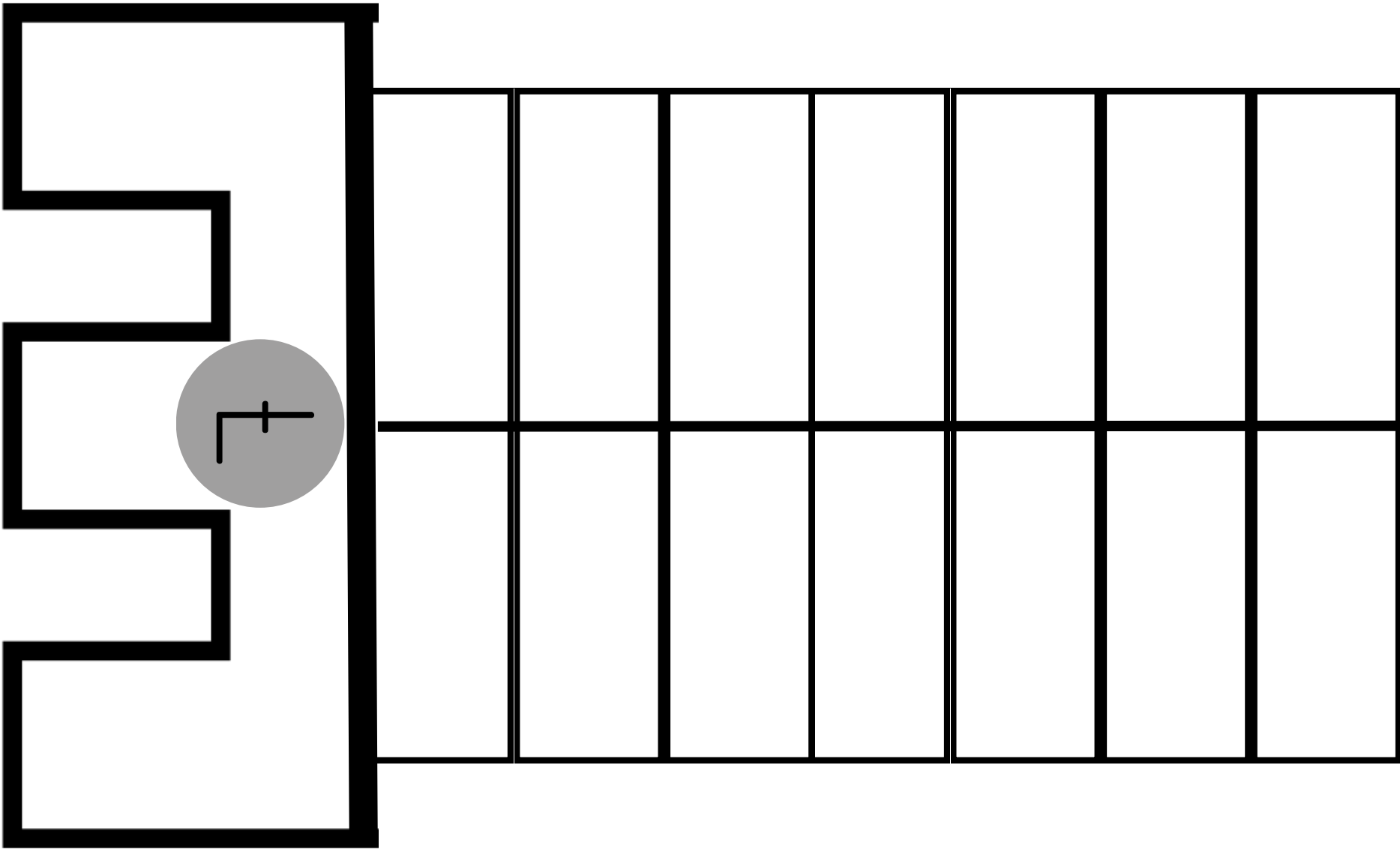
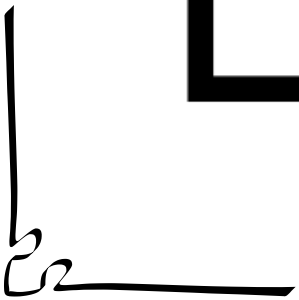

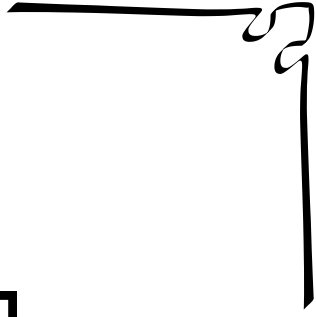
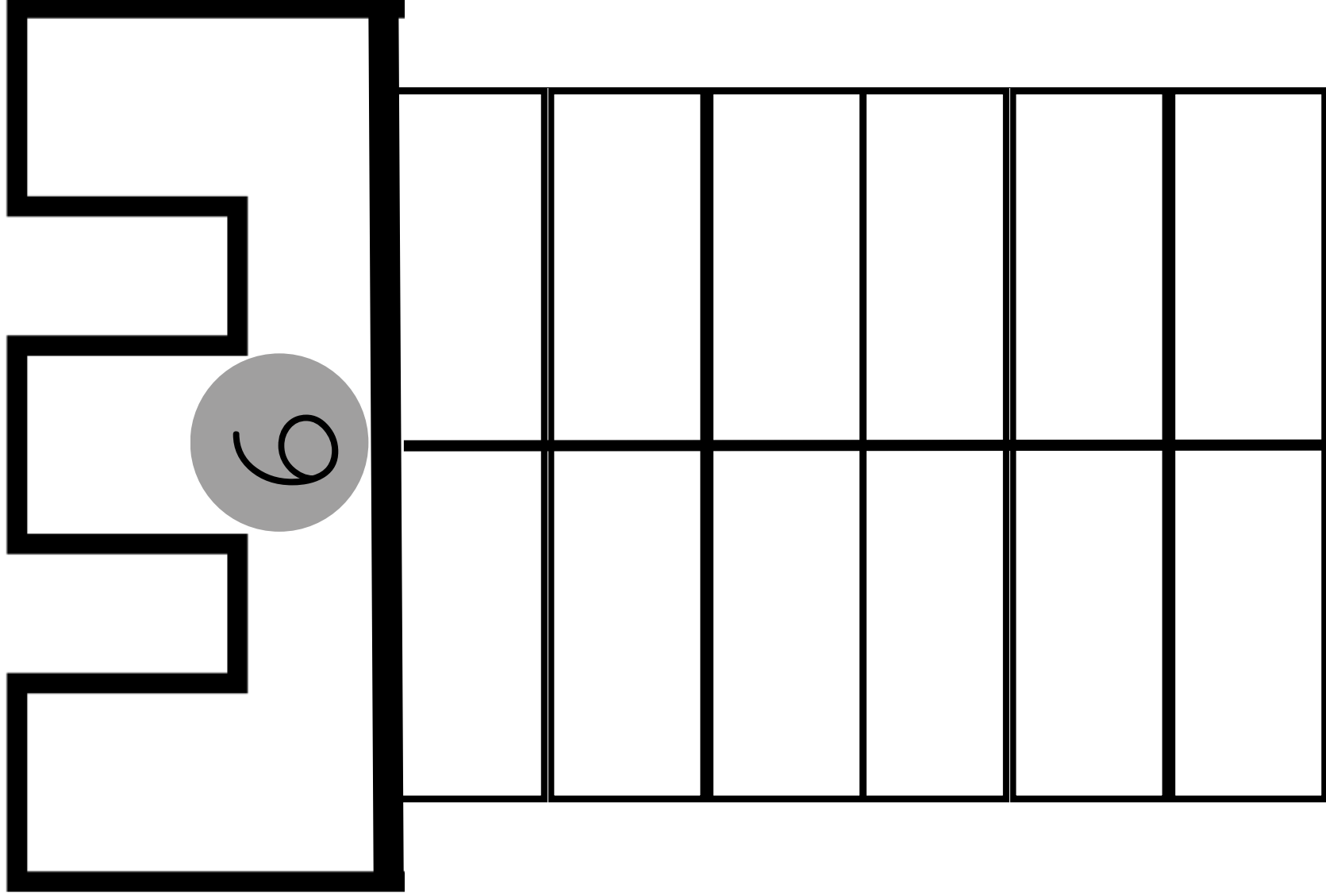
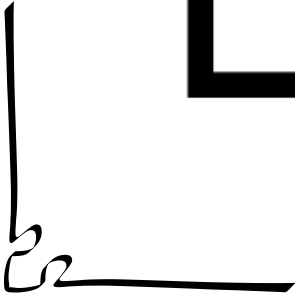

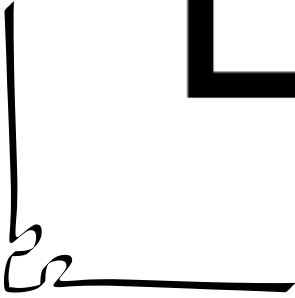

5

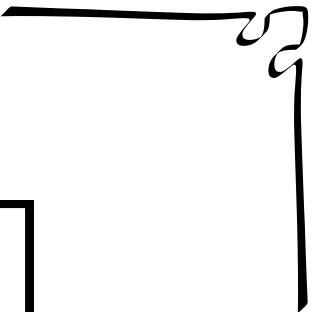

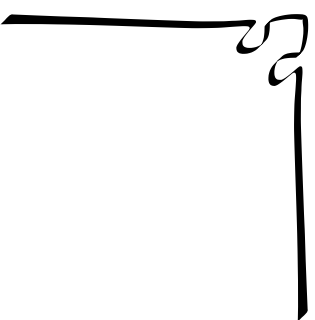
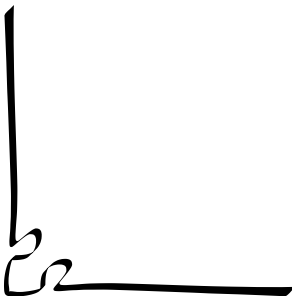
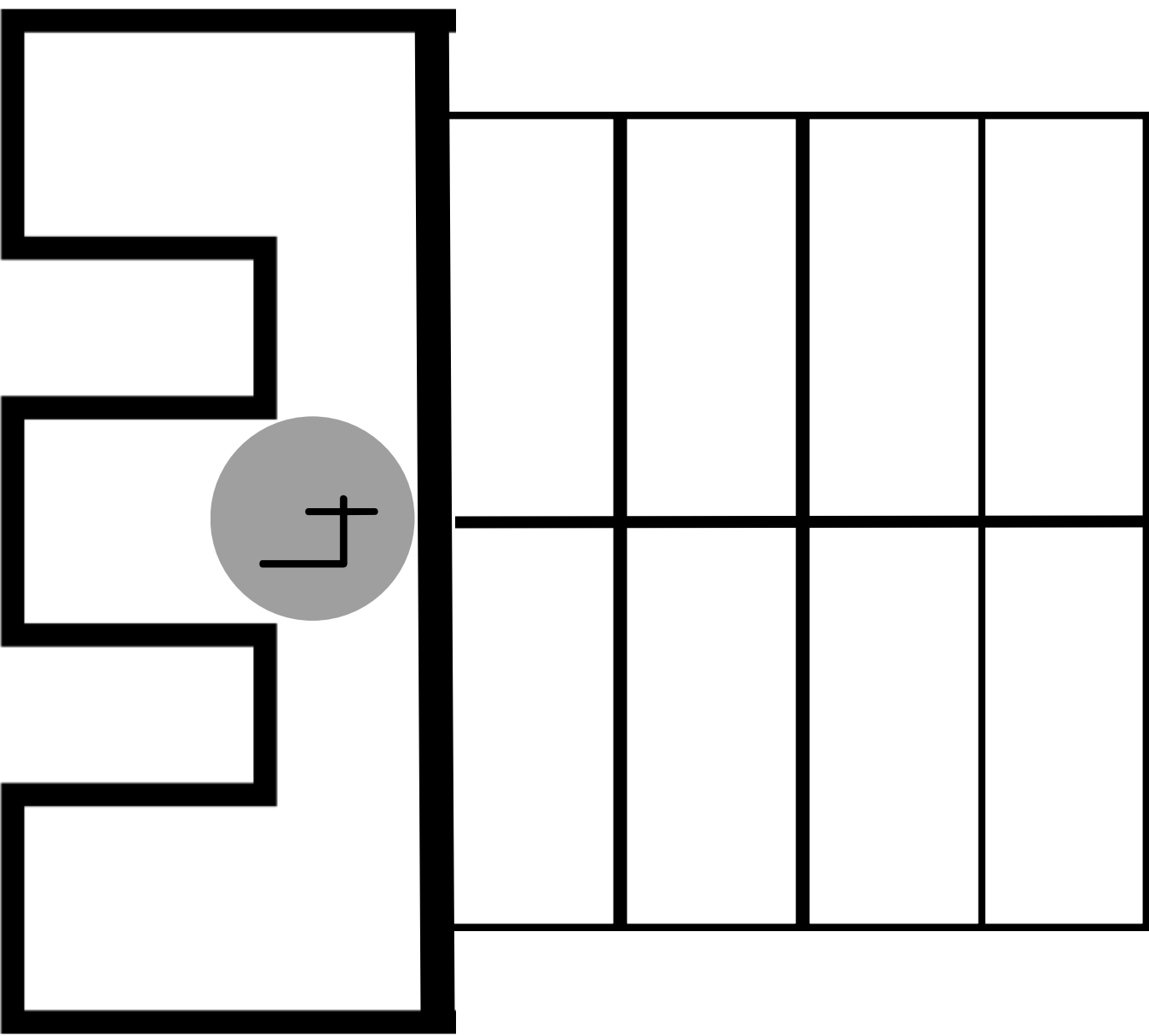

4

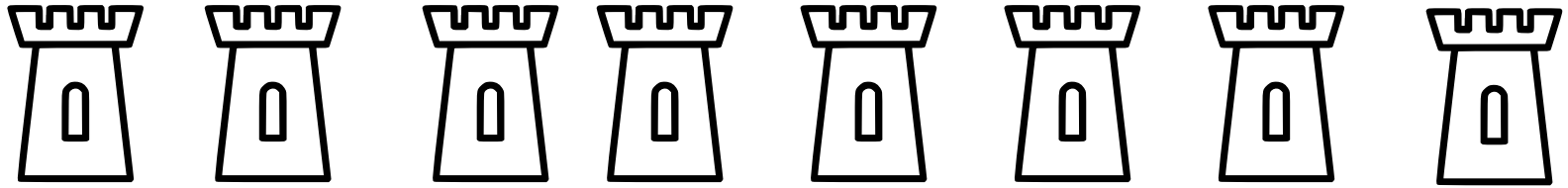

5

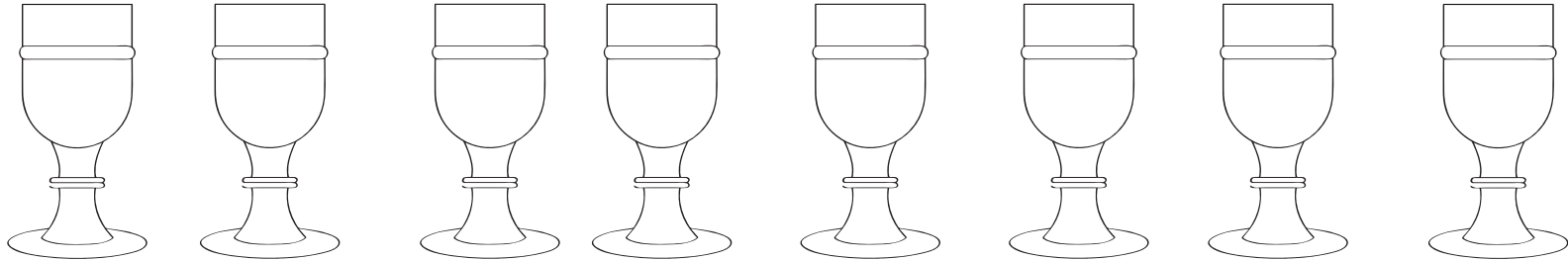

6

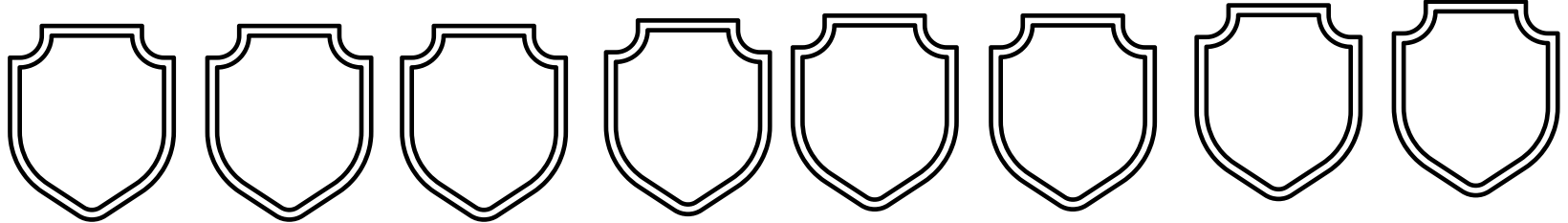

7

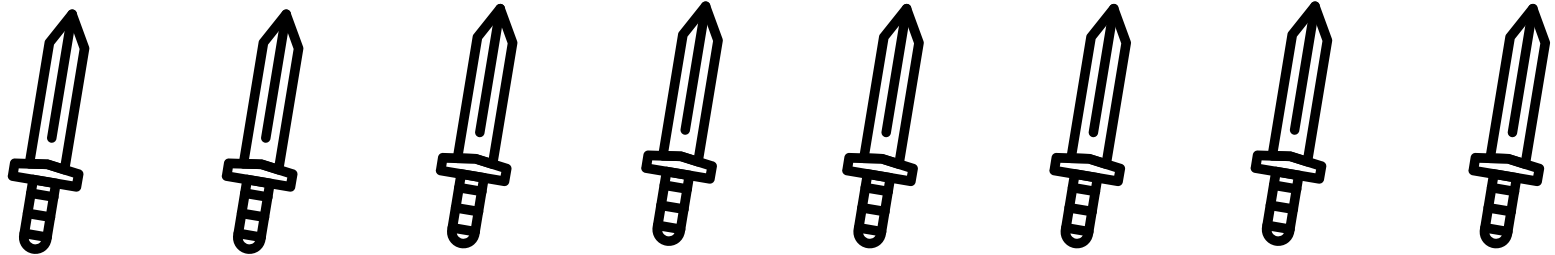

8



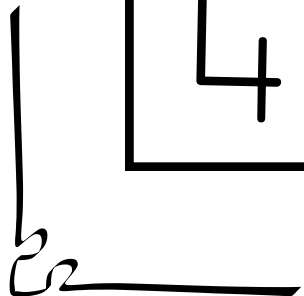
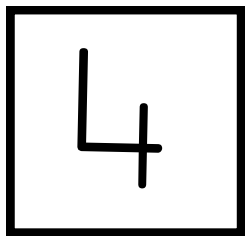
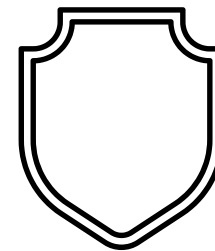
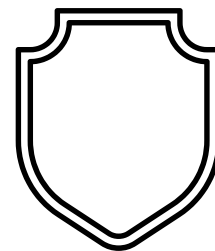
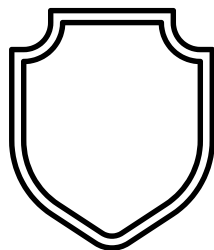
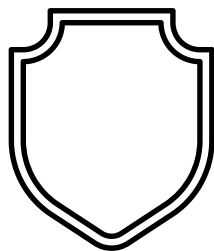
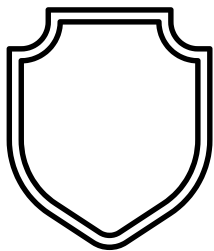
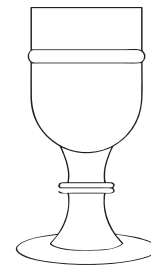
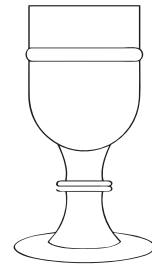
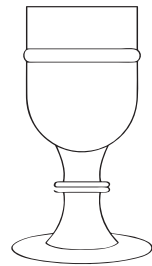
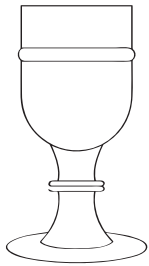
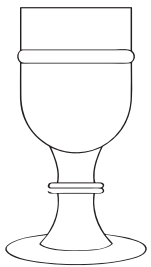
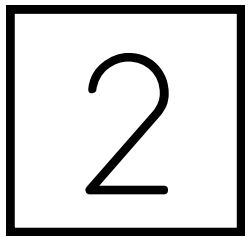
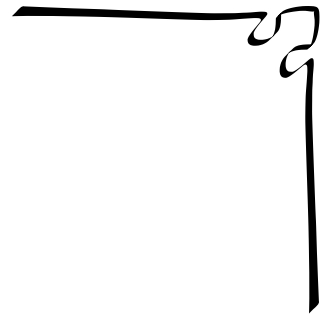
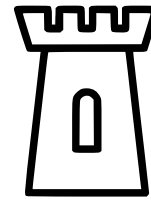
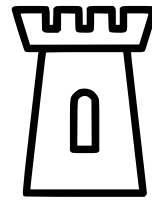
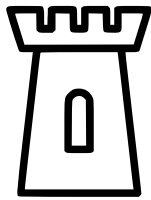
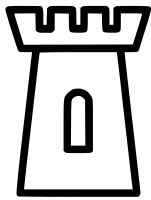
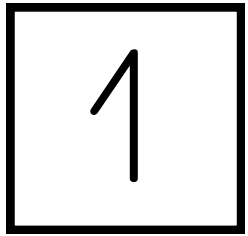

Pega aquí las piezas del puzzle.

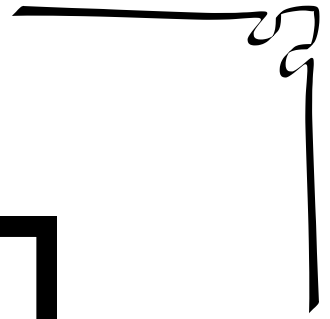
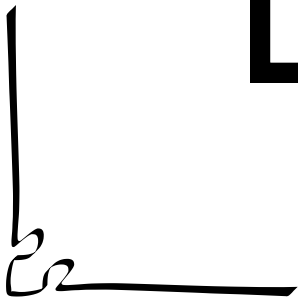

Colorear y recorta las piezas del puzzle.

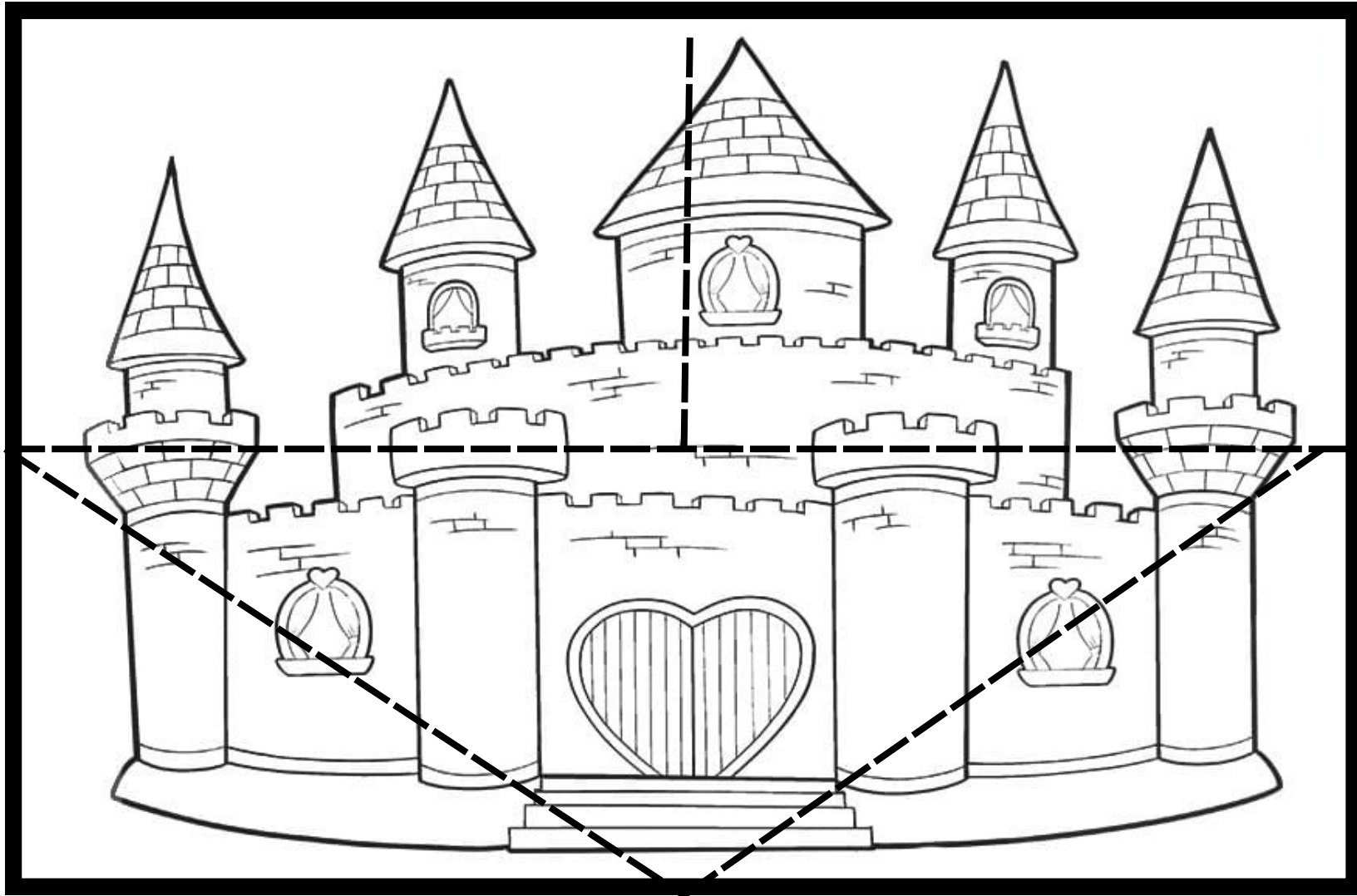

Colorear y recorta las piezas del puzzle.

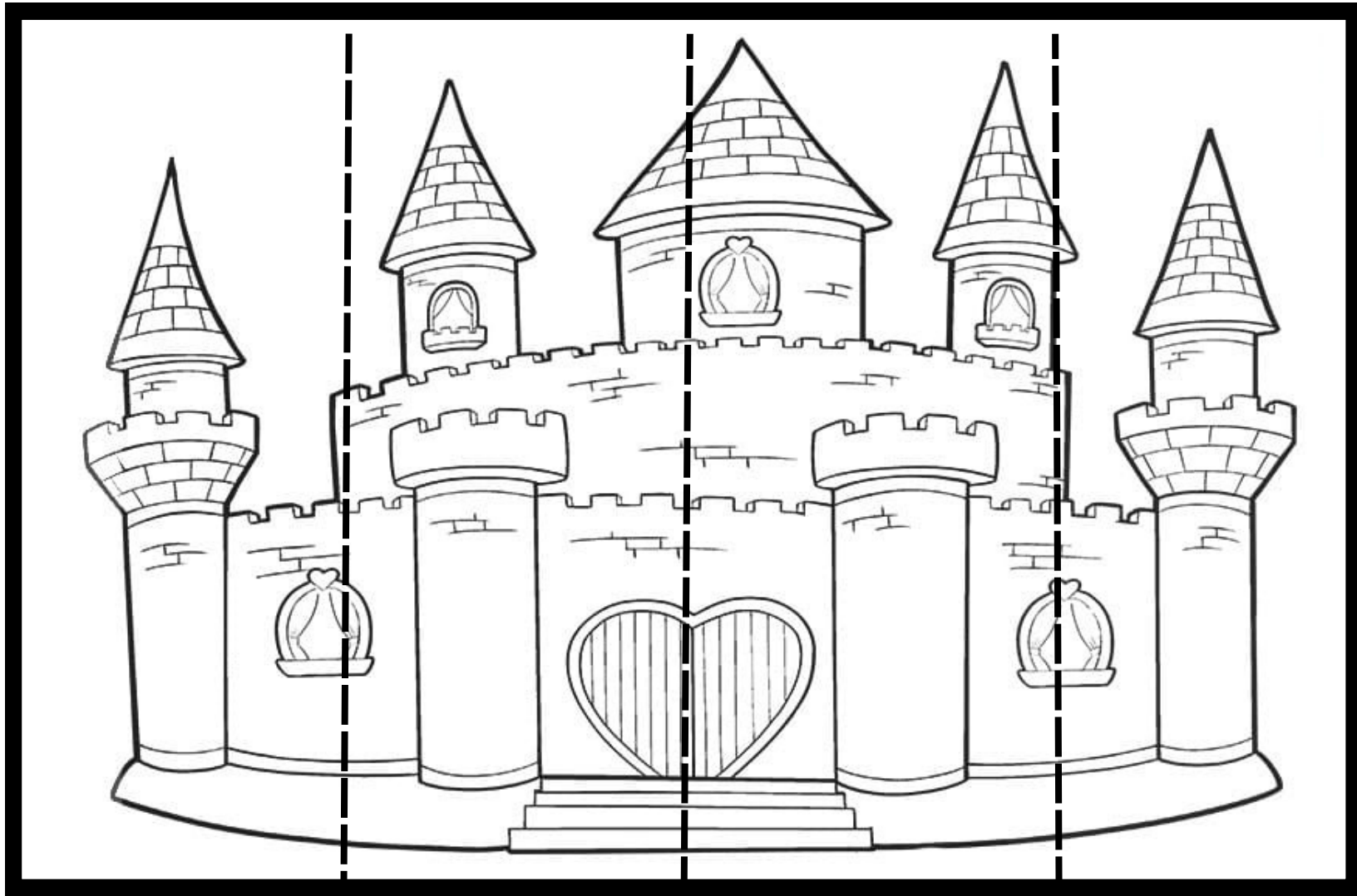



BANQUETE

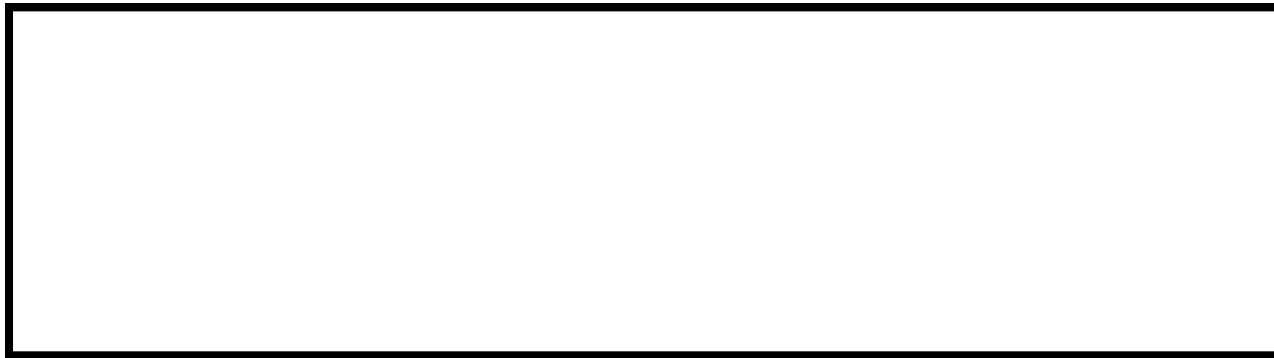



Banquete

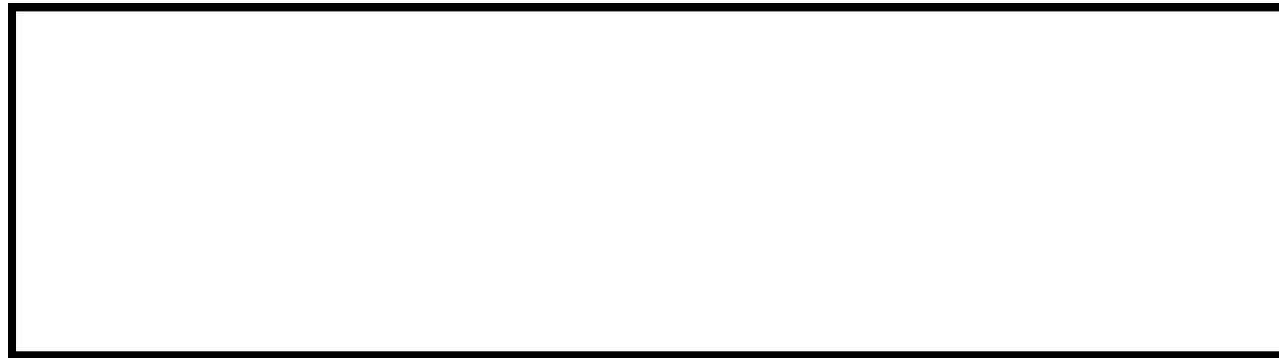

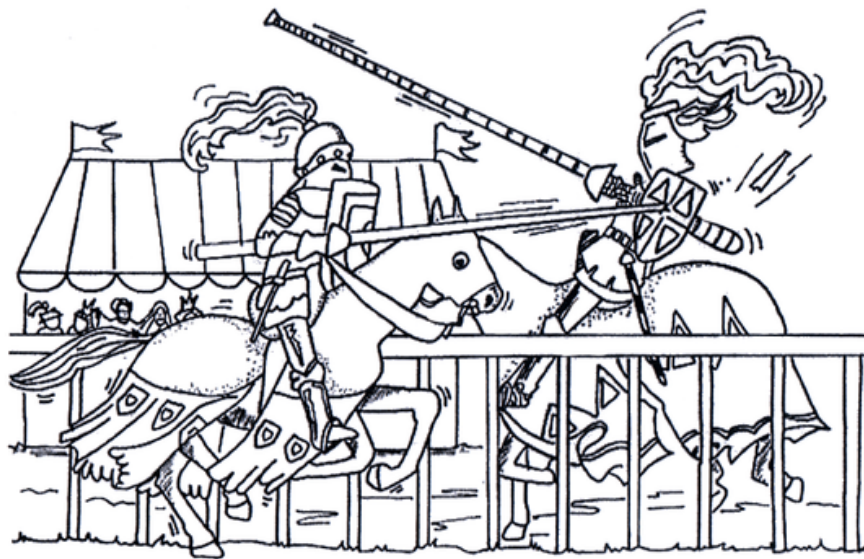

Torneo

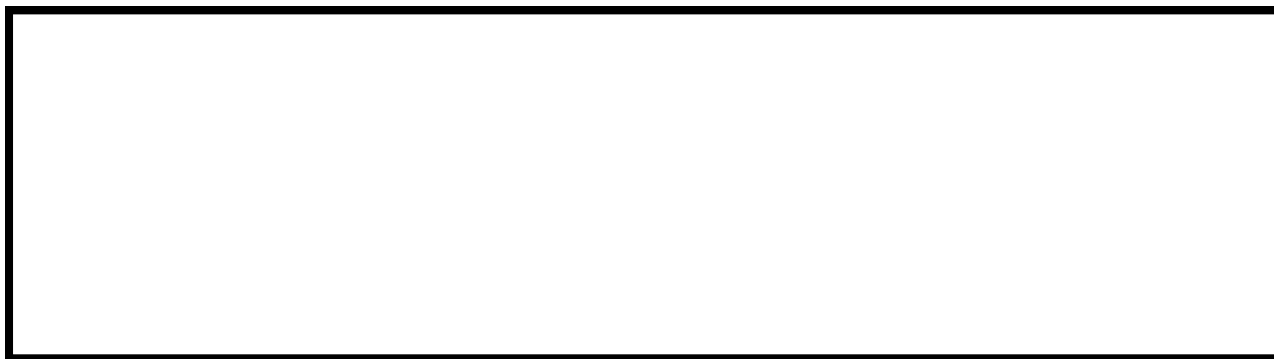

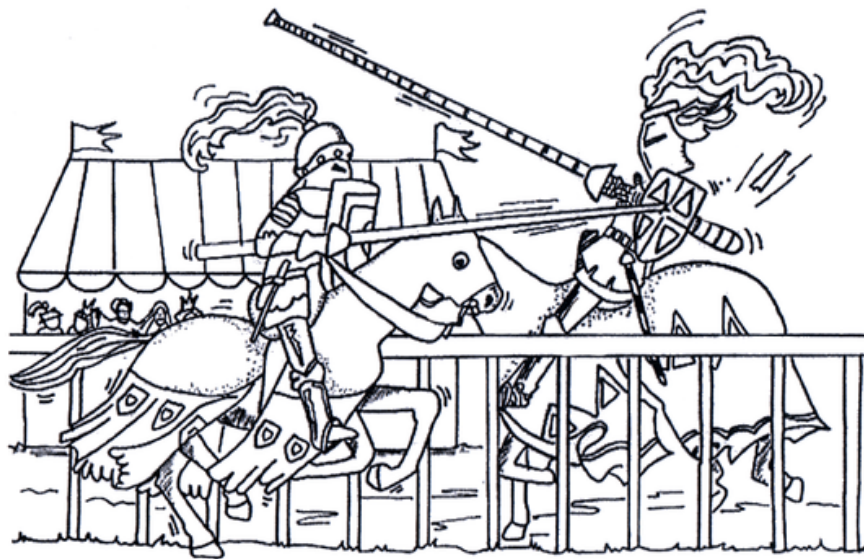

TORNEO

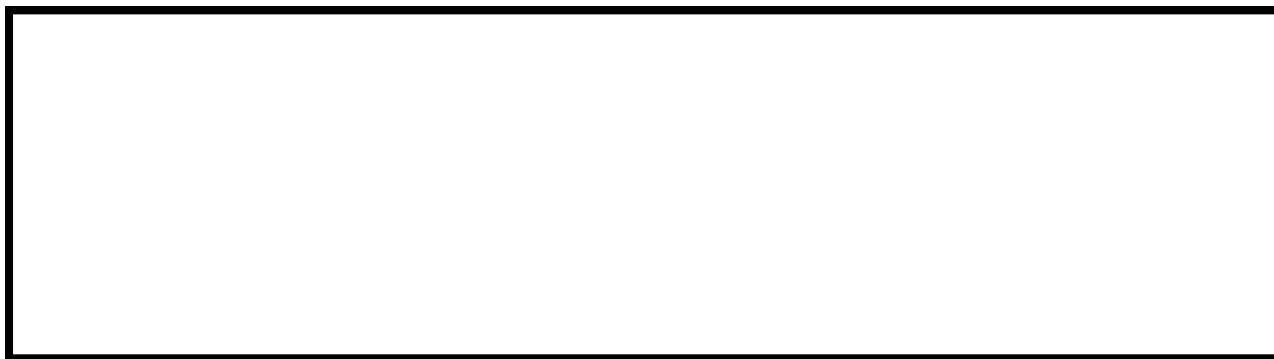



CACERÍA





Cacería

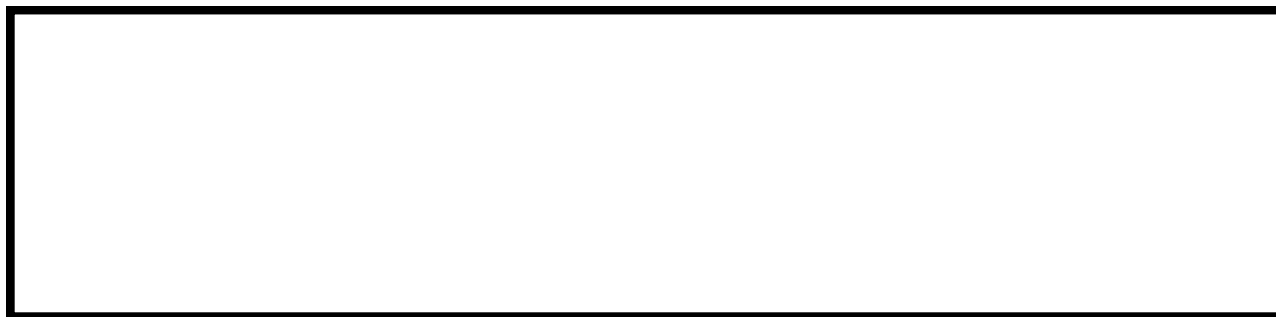

SUS COSTUMBRES



Pon una pegatina en las costumbres que había en los castillos, compara con la vida actual.

LOS PASATIEMPOS

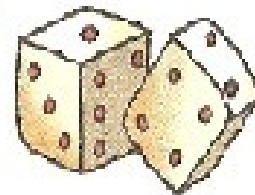
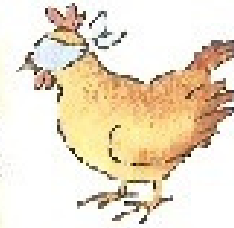
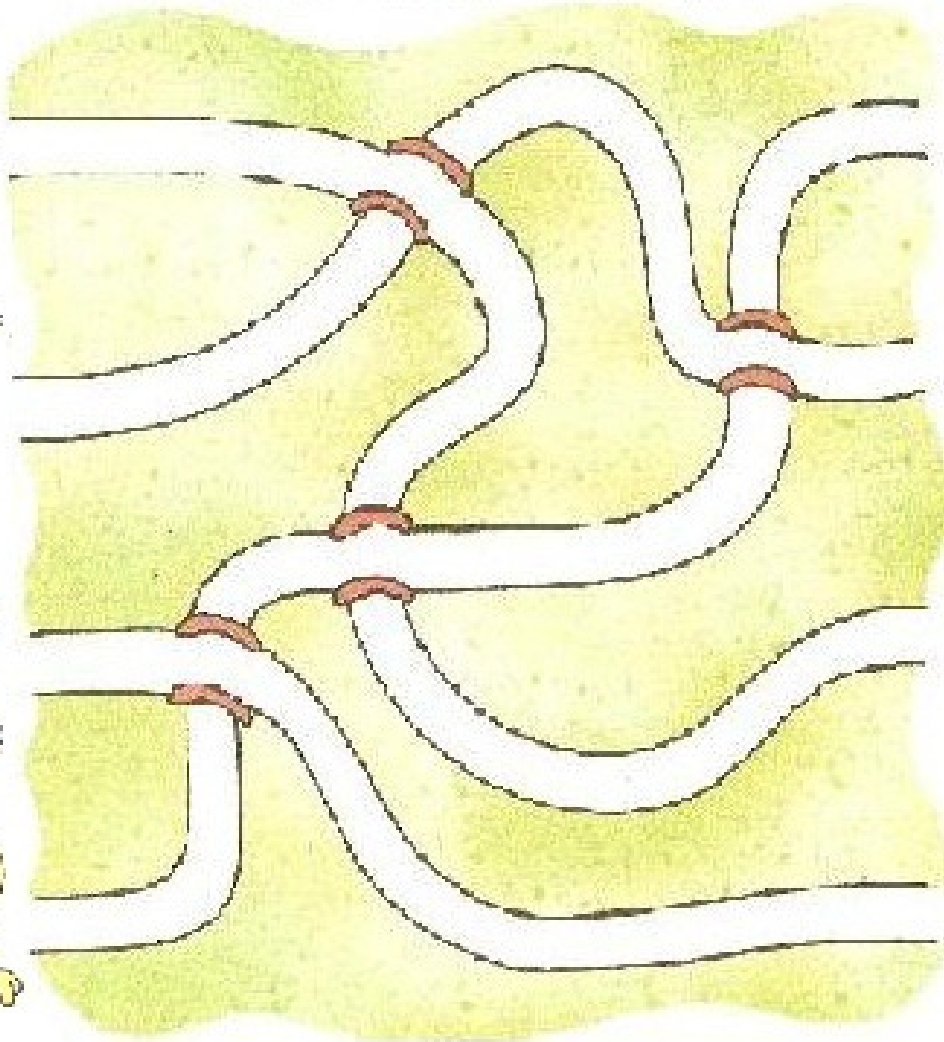

Juega con los dados:

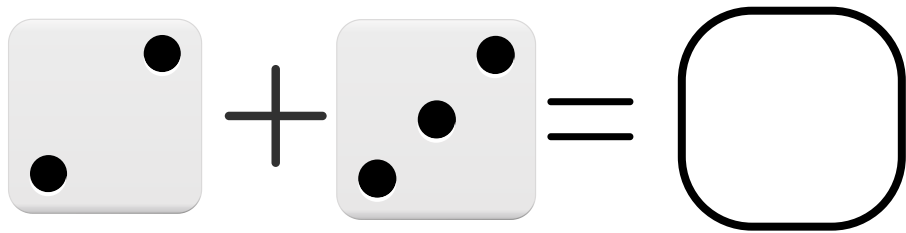

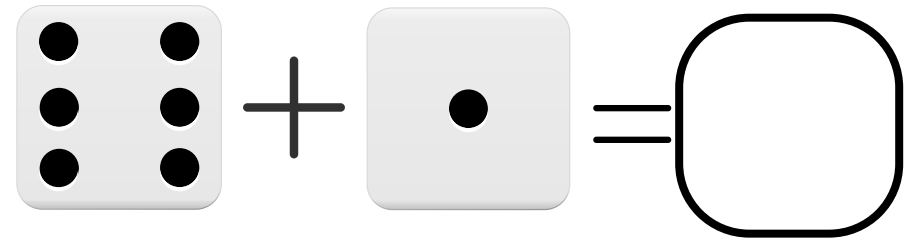
$$2 + 3 = \square$$

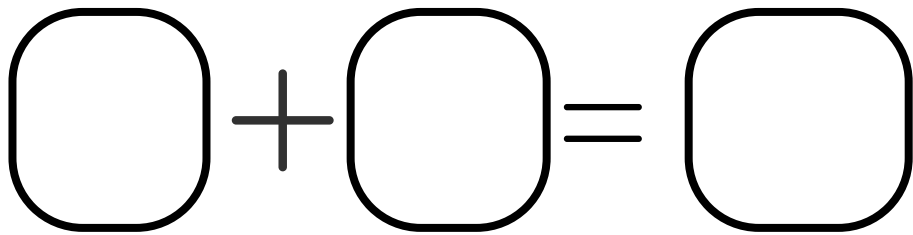

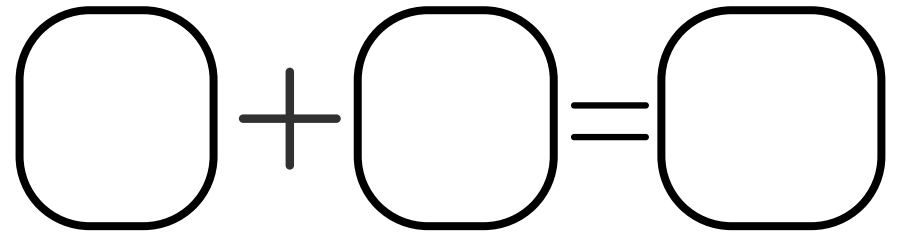
$$6 + 1 = \square$$

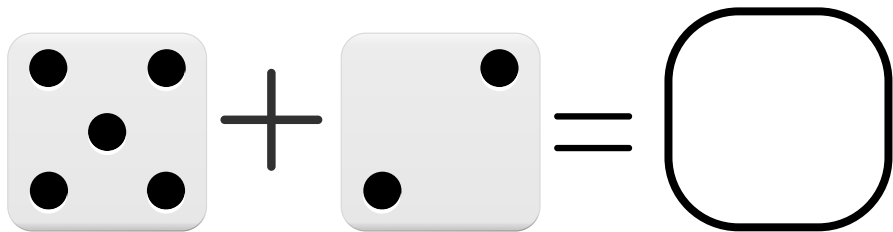

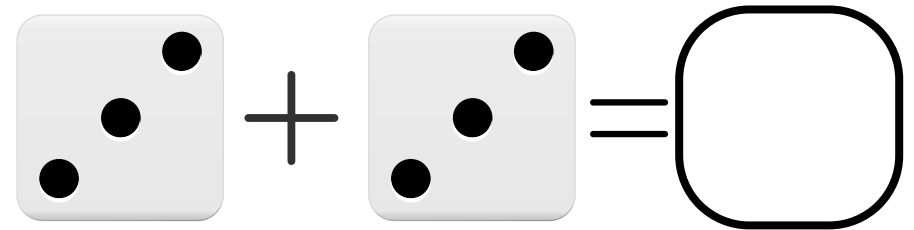
$$\square + \square = \square$$

$$\square + \square = \square$$

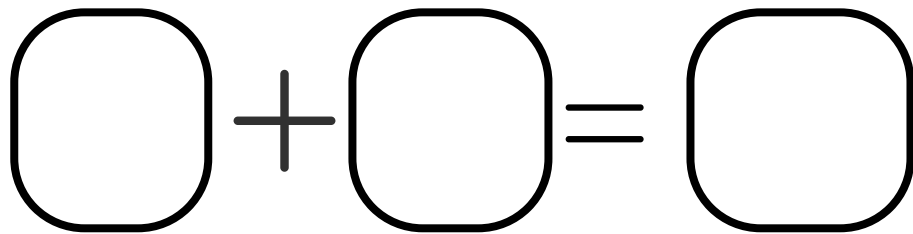

$$5 + 2 = \square$$

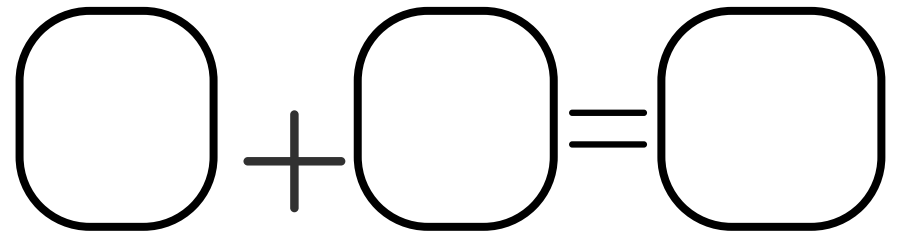
$$3 + 3 = \square$$

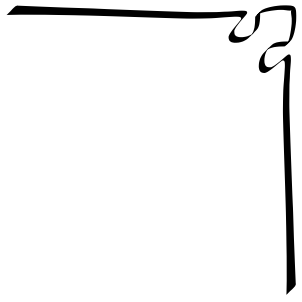

$$\square + \square = \square$$

$$\square + \square = \square$$

¿QUÉ HE APRENDIDO?

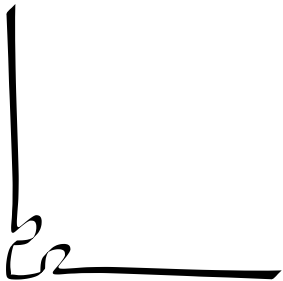

Dibuja un castillo al final de proyecto.



SÍGUEME A TRAVÉS DE:



<https://www.cocinandosuenos.es>



@COCINANDOSUENOSMT

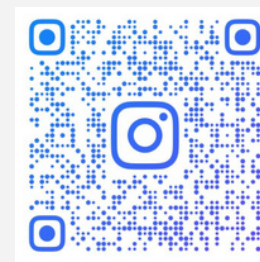

<https://www.facebook.com/csmaestra>

Este material está bajo licencia (CC BY-NC-ND 4.0)

